

Die Produkt Artikelnummern entsprechen unseren Artikelnummern.

Die Artikel sowie Preis finden Sie im Online Shop.

Geben Sie unter "Suche" die Artikelnummer ein.

Sollten Sie einen Artikel nicht in unserem Online Shop finden; einfach eine Produkthanfrage per E-Mail:

[info@loeffler-quads.de](mailto:info@loeffler-quads.de) senden.

[www.loeffler-quads.de](http://www.loeffler-quads.de)

Alexander Löffler GmbH

Reutlinger Str. 90

72116 Mössingen - Öschingen

Deutschland

Telefon: 074737620

E-Mail: [info@loeffler-quads.de](mailto:info@loeffler-quads.de)



# 2020 MOTORCYCLE ACCESSORIES

 **ariete**®

MANUFACTURED IN ITALY  Since 1947

WELCOME TO



MANUFACTURED IN ITALY  Since 1947



## IT ESCLUSIONE DI RESPONSABILITÀ

I prodotti Ariete, Ari ed Harri's, pur essendo di altissima qualità, non possono prevenire danni in caso di impatto. Prima di utilizzare i prodotti Ariete, Ari ed Harri's Vi preghiamo di leggere attentamente le istruzioni fornite per l'uso ed il montaggio. La Sandro Mentasti Srl compie ogni sforzo al fine di assicurare che le informazioni contenute nel presente catalogo siano corrette e dettagliate, nonché di facile comprensione, ma declina ogni responsabilità per eventuali errori di interpretazione ed in caso di dubbi, anche in merito al montaggio e/o alle condizioni per l'uso, Vi invita a contattarla all'indirizzo e-mail: [info@ariete.com](mailto:info@ariete.com). In ogni caso, è esclusa la responsabilità della Sandro Mentasti Srl per eventuali danni a cose e/o persone occorsi durante l'uso dei prodotti nonché per eventuali danni derivanti da usi non corretti, speciali, eccezionali e/o comunque diversi da quelli cui il prodotto era stato originariamente destinato, da errori di montaggio e/o di installazione.

La Sandro Mentasti Srl realizza direttamente i propri prodotti, commercializzandoli con i marchi ARIETE, ARI ed HARRI'S. L'utilizzo, all'interno dei cataloghi, di eventuali codici originali di prodotti recanti marchi diversi da quelli summenzionati è da intendersi meramente descrittivo, così come l'eventuale utilizzo di marchi e/o denominazioni di altre case produttrici (a titolo esemplificativo, PIAGGIO®, HONDA®, YAMAHA®, SUZUKI®, KAWASAKI®, BMW®, VESPA®, KYMCO®) cui la Sandro Mentasti Srl non è in alcun modo collegata. Tale utilizzo ha il solo fine di descrivere l'accessorio e/o il ricambio.

## UK EXCLUSION OF LIABILITY

Ariete, ARI and Harri's products, while being of very high quality, may be subject to damage in case of impact or accident. Before using Ariete, Ari or Harri's products, please carefully read the instructions for use and installation. Sandro Mentasti Srl makes every effort to ensure that the information contained in this catalogue is correct and easy to understand, with some information specific to individual products, but accepts no responsibility for any misinterpretation. If you should require any further information, regarding assembly and/or conditions for use, please contact Sandro Mentasti Srl by e-mail at [info@ariete.com](mailto:info@ariete.com). In any event, Sandro Mentasti Srl is not liable for any damage to property and/or persons caused during the use of its products, and neither for any damage resulting from incorrect use and/or use other than that for which the product was originally intended, and damage resulting from assembly errors and/or incorrect installation.

Sandro Mentasti Srl manufactures its products directly, and markets them with the ARIETE, ARI and HARRI'S brands. The use contained within the catalogues of any original product codes bearing brands other than those mentioned above is intended as merely descriptive, as well as the possible use of trademarks and / or names of other manufacturers (for example, PIAGGIO®, HONDA®, YAMAHA®, SUZUKI®, KAWASAKI®, BMW®, VESPA®, KYMCO®) which Sandro Mentasti Srl is in no way connected. The only purpose of this use is to describe the accessory and/or the part.



## FR CLAUSE DE NON RESPONSABILITÉ

Les produits Ariete, Ari et Harri's, bien que de très haute qualité, ne peuvent pas éviter des dommages en cas d'impact. Avant toute utilisation d'un produit Ariete, Ari et Harri's nous vous demandons de bien vouloir lire attentivement les notices fournies pour l'utilisation et le montage. Sandro Mentasti Srl met tout en œuvre pour assurer que les informations contenues dans le présent catalogue soient correctes et détaillées, faciles à comprendre, mais la Société décline toute responsabilité pour d'éventuels erreurs d'interprétation et en cas de doutes, soit sur le montage que sur les conditions d'utilisation, vous êtes invités à la contacter l'adresse e-mail: [info@ariete.com](mailto:info@ariete.com). En tout cas, toute responsabilité de la part de la Société Sandro Mentasti Srl est exclue pour éventuels dommages corporels et/ou matériels produits lors de l'utilisation de ses produits, ainsi que tout dommage dérivant d'une utilisation inappropriée, spéciale, exceptionnelle et/ou de toute manière différente de celle à laquelle le produit avait été initialement destiné, ou provoqué par des erreurs de montage et/ou d'installation.

La Société Sandro Mentasti Srl réalise directement tous les produits qu'elle commercialise avec les marques ARIETE, ARI et HARRI'S. L'utilisation, dans les catalogues, d'éventuels codes originaux de produits avec des marques différentes, se veut être purement descriptif. De même pour l'utilisation de marques et/ou dénominations d'autres fabricants (entre autres, par exemple, PIAGGIO®, HONDA®, YAMAHA®, SUZUKI®, KAWASAKI®, BMW®, VESPA®, KYMCO®) avec qui la Société Sandro Mentasti Srl n'a aucun lien. Ces marques/dénominations sont utilisées uniquement pour décrire l'accessoire et/ou la pièce détachée.

## ES EXCLUSIÓN DE RESPONSABILIDAD

Los productos Ariete, Ari y Harri's, incluso siendo de gran calidad, no pueden prevenir daños en caso de impacto. Antes de utilizar los productos Ariete, Ari y Harri's les rogamos que lean con atención las instrucciones de uso y montaje. La Sandro Mentasti Srl hace todo lo posible para asegurar que la información que contiene el presente catálogo sea correcta y detallada, así como de fácil comprensión, pero declina toda responsabilidad sobre posibles errores de interpretación; y, en caso de que tengan dudas sobre el montaje y/o condiciones de uso, les invita a ponerse en contacto con la dirección de correo electrónico: [info@ariete.com](mailto:info@ariete.com). En cualquier caso, se excluye la responsabilidad de la empresa Sandro Mentasti Srl sobre posibles daños a cosas y/o personas que pudieran ocurrir durante la utilización de los productos, así como sobre posibles daños derivados de una utilización incorrecta, especial o excepcional y/o, en cualquier caso, diferente del uso para el que el producto ha sido, en origen, destinado; tanto por errores de montaje como de instalación.

La empresa Sandro Mentasti Srl realiza directamente sus propios productos y los comercializa con la marca ARIETE, ARI & HARRI'S. La mención en el catálogo de posibles códigos originales de productos que lleven marcas y/o denominaciones de otras casas productoras distintas a las mencionadas, son meramente descriptivos, así como una posible mención de otras casas productoras (a título de ejemplo, PIAGGIO®, HONDA®, YAMAHA®, SUZUKI®, KAWASAKI®, BMW®, VESPA®, KYMCO®) con las que la empresa Sandro Mentasti Srl no tiene ningún tipo de vínculo. Tal uso tiene como única finalidad describir el accesorio y/o recambio.

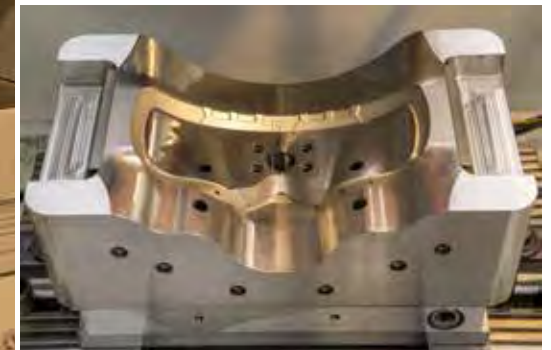

OFF-ROAD GOGGLES

LIGHT ENDURO ROAD GOGGLES

OFF-ROAD GRIPS/ACCESSORIES

ROAD GRIPS/ACCESSORIES

TECHNICAL PARTS/ACCESSORIES

Mudmax Goggles	16
Mudmax Enduro Goggles	20
Mudmax Anvil Goggles	22
Mudmax Easy Goggles	24
Adrenaline Primis Plus Goggles	28
Adrenaline Profi Plus Goggles	32
RC Flow Goggles	36
Rally Goggles	39
Snowmobile Goggles	40
07 Next Gen Goggles	44
Lenses for Adrenaline – RC – Mudmax	48
Lenses for 07 Next Gen	50
Tear-offs	52
Big/XL Roll-off	54
RC Spare parts	58
Merchandising	59
Mudmax Racer Goggles	60
Mudmax Racer Special Goggles	63
Feather Goggles	64
Feather Lite Goggles	68
Vintage Goggles	72
Vulcan grips	76
Trinity grips	78
Duality Grips	80
Unity Grips	81
Kids Grips	83
ATV-Cycle   Trial   Rally   Classic Grips	84
Off-Road Accessories	85
Fork Gaiters	88
Ariram Grips	90
Aries Grips	92
Estoril Road Grips	93
Standard road Grips	95
Ariete Heritage Grips	100
Grips by Brand	104
Scooter Grips	110
Harri's Grips & Tank protectors	114
Aluminium Racing Valves	116
ARI The Original Fork Oil Seals	118
Brake Caliper – Master Cylinder Seal Kits	128
DOT3-DOT4 Fluid pipe	129
Fuel Pipes	130
Merchandising	132

## IT CERTIFICAZIONI

La nostra Qualità è frutto di 70 anni di lavoro

La qualità nasce e si estende in un sistema di gestione che integra controlli dei prodotti e dei processi.

Il pieno controllo di tutte le fasi costruttive dei prodotti ci permette di assicurare al cliente il rispetto dei requisiti richiesti, ma ciò che più conta, ci permette di offrire la garanzia di un servizio sempre impeccabile.

Sandro Mentasti Srl ha ottenuto la certificazione del proprio Sistema di Gestione per la Qualità e Sicurezza con l'Ente di Certificazione **TUV THURINGEN e.V.**

## UK CERTIFICATIONS

Our Quality is the result of 70 years of work

The quality starts and progresses into a management system that integrates checks on products and processes.

The full control over all the manufacturing steps allows us to fully comply with the Client's requirements, but more importantly, enables us to offer the guarantee of a flawless service, at any moment.

Sandro Mentasti Srl has received the certification issued by the **TUV THURINGEN e.V** Certification Body, for its own Quality and Safety Management System.

## FR CERTIFICATIONS

Notre Qualité est le fruit de 70 ans de travail

La qualité naît et se développe dans un système de gestion qui intègre le contrôle des produits et des processus.

Le monitoring général de toutes les phases de fabrication des produits, nous permet de garantir au client le respect des critères requis, mais surtout cela nous permet d'offrir la garantie d'un service toujours impeccable.

Sandro Mentasti Srl a obtenu la certification pour son propre Système de Gestion pour la Qualité et la Sécurité avec l'Organisme de Certification **TUV THURINGEN e.V.**

## ES CERTIFICACIONES

Nuestra Calidad es el resultado de 70 años de trabajo

La calidad nace y se extiende en un sistema de gestión que integra los controles de productos y de procesos.

El control total de todas las fases de fabricación de los productos nos permite asegurar que el cliente cumpla con los requisitos, pero lo más importante es que nos permite ofrecer la garantía de un servicio siempre impecable.

Sandro Mentasti Srl ha obtenido la certificación de su Sistema de Gestión de Calidad y Seguridad con **TUV THURINGEN e.V.**





## #I\_AM\_ARIETE\_ORIGINAL



**IT** | I prodotti ARIETE® originali garantiscono il rispetto degli standard di qualità e salvaguardia dell'Ambiente stabiliti dal severo disciplinare della Sandro Mentasti Srl.

Ultimamente circolano nei mercati mondiali delle imitazioni dei nostri prodotti Ariete®, HARRI'S®, ARI® the original fork oil seals.

Queste imitazioni di basso livello qualitativo rappresentano un rischio per la sicurezza dell'Utilizzatore sia in strada che in Off-Road.

**ATTENZIONE NON COMPERATE PRODOTTI CONTRAFFATTI e NON ORIGINALI**

**Per scoprire se il prodotto acquistato è originale Ariete® oppure è contraffatto applichiamo sulle confezioni originali un ologramma che permette di controllarne l'autenticità con pochi passi.**

**UK** | Be assured that the original ARIETE® products guarantee compliance with the highest measures of quality and Environmental protection set by the strict standards of Sandro Mentasti Srl.

Recently, many imitations of our Ariete® products have been put on the market, also imitations of our HARRI'S® and ARI®-the original fork oil seals.

These low-quality models pose a risk to the user's safety both on the road and off-road.

**WARNING: DO NOT BUY COUNTERFEIT and NON-ORIGINAL PRODUCTS**

**In order to find out whether the purchased item is original by Ariete® or is counterfeit, we apply a hologram to the original packaging to check its authenticity in a few easy steps.**

**FR** | Les produits ARIETE® originaux garantissent le respect des standards de qualité et de sauvegarde de l'Environnement fixés par la stricte réglementation adoptée par la Société Sandro Mentasti Srl. En ce moment, on trouve sur les marchés du monde entier des imitations de nos produits Ariete®, HARRI'S®, ARI® the original fork oil seals.

Ces imitations de second ordre au niveau qualitatif représentent un risque pour la sécurité des Utilisateurs soit dans les rues que dans le Off-Road.

**ATTENTION A' NE PAS ACHETER DES PRODUITS CONTREFAITS ET NON ORIGINAUX**

**Lorsque vous achetez un produit Ariete®, pour découvrir s'il s'agit d'un produit original ou d'une contrefaçon il suffit de vérifier s'il porte l'hologramme que nous appliquons sur les confections originales qui permet d'en vérifier l'authenticité en quelques clics.**

**ES** | Los productos ARIETE® originales garantizan el cumplimiento de los estrictos estándares de calidad y medioambientales de Sandro Mentasti Srl.

En algunos mercados están circulando imitaciones de nuestras marcas registradas Ariete®, HARRI'S®, ARI® the original fork oil seals.

Estas imitaciones de baja calidad representan un riesgo para la seguridad del usuario tanto en carretera como Off-Road.

**ADVERTENCIA: NO USE PRODUCTOS NO ORIGINALES O FALSIFICADOS**

**Para saber si un producto comprado Ariete® es original o falso, incluimos un holograma en el embalaje original para verificar su autenticidad en unos pocos pasos.**



**WWW.ARIETE.COM | ARIETE AUTHENTICITY**

**IT** Collegandosi al sito [www.ariete.com](http://www.ariete.com) ed entrando nella sezione "Ariete Authenticity" si viene ridirezionati al sito ufficiale

**UK** Go to [www.ariete.com](http://www.ariete.com) and enter the "Ariete Authenticity" section and you will be redirected to the official website

**FR** D'aller sur le site [www.ariete.com](http://www.ariete.com) et cliquer sur la section "Ariete Authenticity". Vous serez automatiquement renvoyés sur le site officiel

**ES** Conéctese a [www.ariete.com](http://www.ariete.com) y entre en la sección "Ariete Authenticity" donde se re-direccionará al sitio web oficial

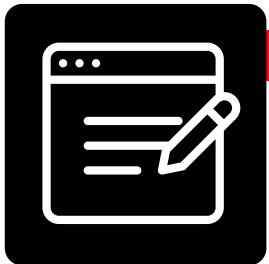
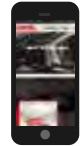
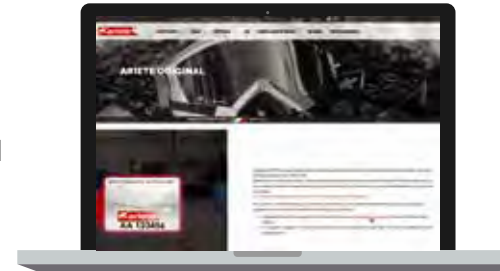

**SIGN UP | TYPE THE CODE**

**IT** Ci si registra e si digitano i 13 numeri del codice a barre o in alternativa il codice alfa-numerico di 2 lettere e 6 numeri dell'ologramma

**UK** Register and enter the 13-bar code number or, alternatively, the alpha-numeric code of 2 letters and 6 hologram numbers

**FR** Vous vous enregistrez et en saisissant les 13 chiffres du code à barre, ou le code alphanumérique de 2 lettres et 6 chiffres de l'hologramme

**ES** Una vez allí, debe registrarse y escribir los 13 números del código de barras o alternativamente el código alfa-numérico de 2 letras y 6 números del holograma

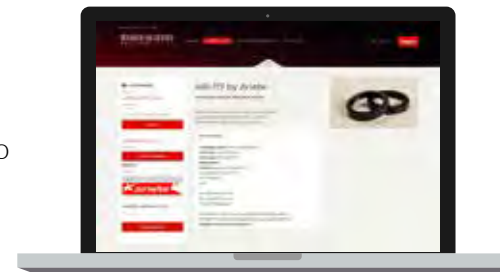
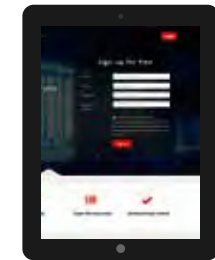

## ABBIAMO UN CUORE VERDE

Sandro Mentasti Environmental Protection Program. Varato nel 2007 questo progetto nasce dalla volontà di promuovere ed applicare una cultura interna aziendale più sensibile all'ambiente basata sulla compatibilità tra la nostra industria e la salvaguardia ambientale. Obiettivo dell'impegno la riduzione dei consumi energetici nella produzione, l'eliminazione di materiali tossici ed un adeguato sviluppo della ricerca e dell'innovazione tecnologica orientati al rispetto dell'ambiente naturale. Tutti i nostri articoli commercializzati con i marchi Ariete, Harri's ed ARI sono l'espressione di questa nostra filosofia di dialogo tra ecologia ed industria.

Risultati concreti sono già stati raggiunti nel risparmio energetico distribuito in azienda tramite trasformatori ecologicamente certificati, nella gestione dei rifiuti speciali smaltiti in ottemperanza alle norme di legge da ditte specializzate ed omologate, nella gestione della raccolta differenziata dei rifiuti, nella drastica riduzione del consumo di acqua per mezzo di un impianto a circuito chiuso per il termo-condizionamento di presse ed attrezzature, nell'ottimizzazione dell'impianto di riscaldamento dei reparti e degli uffici con nuove caldaie termiche a condensazione con emissioni quasi nulle nell'atmosfera, nel notevole risparmio della carta per uso interno (modulistica, fotocopie, stampe di e-mail etc.), nell'adozione di imballi e packaging dei prodotti ecologicamente classificati, cataloghi stampati rigorosamente su carta riciclata "certificata".

## WE HAVE A GREEN HEART

Sandro Mentasti Environmental Protection Program. This project, founded in 2007, is born out of the desire to promote and apply a more environmentally friendly business culture based on the compatibility between our industry and environmental protection. The commitment aims at reducing energy consumption in production, at eliminating toxic materials, and looks at a proper development of research and technological innovation with the goal of respecting the natural environment. All of our products marketed with Ariete, Harri's and ARI brands are the expression of our philosophy of dialogue between ecology and industry. Concrete results have already been achieved in the company's energy saving through ecologically certified electrical transformers, in the management of special waste disposed of in compliance with law by specialized and homologated companies, in the management of recycling, in the drastic reduction in water consumption by means of a closed loop system for the thermo-conditioning of presses and equipment, in the optimization of the heating system of the departments and offices thanks to new thermal condensing boilers with almost zero emissions in the atmosphere, in the considerable saving of paper for internal use (forms, photocopies, e-mail prints, etc.), and the adoption of packaging of ecologically classified products, with catalogs printed strictly on "certified" recycled paper.



## NOUS AVONS UN COEUR VERT

Sandro Mentasti Environmental Protection Program. Lancé en 2007 ce projet né de la volonté de promouvoir et appliquer une culture interne d'entreprise plus sensible à l'environnement et fondée sur la compatibilité entre notre identité industrielle et écologique. Nous nous engageons à réduire la consommation d'énergie, à éliminer les matériaux toxiques et à développer la recherche et l'innovation technologique dans le total respect de la nature. Tous nos produits commercialisés avec les marques Ariete, Harri's et ARI reflètent cette philosophie de dialogue entre écologie et industrie. Des résultats concrets ont été déjà atteints avec la réduction des consommations énergétiques grâce à l'adoption des transformateurs écologiquement certifiés, la gestion des déchets spéciaux mis en décharge conformément aux lois par des sociétés spécialisées et homologuées, avec la gestion du triage des déchets, avec la réduction draconienne des consommations d'eau à l'aide d'une installation à circuit fermé pour le thermo conditionnement des presses et des équipements, avec l'optimisation du système de chauffage dans les ateliers et les bureaux avec des nouvelles chaudières thermiques à condensation qui ont des émissions dans l'atmosphère proches à zéro, avec des fortes économies de papier pour l'usage interne (formulaires, photocopies, impression des courriels, etc.), avec l'adoption d'emballages et conditionnements écologiques et avec les catalogues imprimés sur papier recyclé «certifié».

## TENEMOS UN CORAZON VERDE

Lanzado en 2007, este proyecto nace del deseo de promover y aplicar una cultura corporativa interna más sensible con medio ambiente, basada en la compatibilidad entre nuestra industria y la protección del mismo. El objetivo de nuestro compromiso es reducir el consumo de energía en la producción, eliminar los materiales tóxicos y desarrollar de un modo adecuado la investigación y la innovación tecnológica orientadas hacia el respeto del medio ambiente natural. Todos nuestros productos, comercializados bajo las marcas Ariete, Harri's y ARI, son la expresión de nuestra filosofía de diálogo entre la ecología y la industria. Ya se han obtenido resultados concretos en el ahorro energético distribuido en la empresa a través de transformadores ecológicamente certificados, en la gestión de residuos especiales eliminados de acuerdo con la normativa legal por empresas especializadas y homologadas, en la gestión de la recogida selectiva de residuos, la drástica reducción del consumo de agua mediante un sistema de circuito cerrado para el termocondicionamiento de prensas y equipos, en la optimización del sistema de calefacción de departamentos y oficinas con nuevas calderas térmicas de condensación con emisiones a la atmósfera prácticamente nulas, en el considerable ahorro de papel para uso interno (formularios, fotocopias, impresiones de correos electrónicos, etc.) y en la utilización de embalajes y packaging de productos ecológicamente clasificados, así como en catálogos impresos estrictamente en papel reciclado "certificado".



## RACE-BASED DEVELOPMENT

**IT** Ogni progetto viene affinato con innumerevoli tests pratici da parte dei migliori Piloti dei campionati mondiali delle diverse discipline Off-Road. Tutti i suggerimenti dei Piloti vengono elaborati e trasferiti nella maschera finale che viene poi certificata dall'Ente Certificatore.

**UK** Each project is refined and tested by Ariete riders in relevant off-road world championship events. Rider feed-back is agreed and incorporated into the final design before this is submitted to the certifying authority for approval.

**FR** Chaque projet est perfectionné avec d'innombrables essais pratiques par les meilleurs Pilotes des championnats du monde des différentes disciplines Off-Road. Toutes les suggestions des Pilotes sont traitées et transférées dans les lunettes finales qui sont par la suite certifiées par l'Autorité de certification.

**ES** Cada proyecto se mejora con numerosas pruebas prácticas efectuadas por los más destacados Pilotos de los campeonatos mundiales de las diferentes disciplinas Off-Road. Todas las sugerencias de los Pilotos se procesan y se aplican a la máscara final, la que luego será certificada por la entidad correspondiente.

## FIELD OF VISION

**IT** I Tecnici Ariete hanno sviluppato un frame che permette un ampio campo visivo sia lateralmente che verticalmente consentendo al Pilota la massima visibilità dell'ambiente che lo circonda a tutto vantaggio della sicurezza. Le maschere Mudmax, Adrenaline e RC permettono l'uso di occhiali da vista (OTG).

**UK** Ariete technicians have developed a frame that allows a wide field of view both laterally and vertically. This feature makes a vital contribution to rider safety. Mudmax, Adrenaline and RC goggles are OTG – over the glasses models.

**FR** Les Techniciens de Ariete ont développé une monture qui offre un large champ visuel soit sur les côtés soit verticalement, ce qui donne au Pilote une visibilité périphérique maximale au plus grand profit de la sécurité. Les lunettes Mudmax, Adrenaline et RC permettent de garder les lunettes de vision (OTG).

**ES** Los técnicos de Ariete han desarrollado un marco que permite un amplio campo de visión, ya sea lateral como verticalmente, lo que consiente al Piloto la máxima visibilidad del ambiente que lo circunda en beneficio de su seguridad. Las gafas Mudmax, Adrenaline y RC permiten el uso con gafas correctivas (OTG).

## ERGONOMICS AND AVANT-GARDE DESIGN

**IT** Il design delle maschere Ariete nasce dalle esigenze del Pilota nelle condizioni più estreme. I Tecnici Ariete hanno puntato sull'ergonomia del frame che si adatta perfettamente alla conformazione del viso.

**UK** The shape of Ariete goggle frames was born from experience under extreme conditions. Ariete technicians have focused on the ergonomics of the frame to ensure that it perfectly fits the rider's face.

**FR** Le design des lunettes Ariete naît des exigences du Pilote dans les conditions les plus extrêmes. Les techniciens de Ariete ont misé sur l'ergonomie de la monture qui s'adapte à la conformation du visage.

**ES** El diseño de las máscaras Ariete nace de las exigencias del Piloto en condiciones extremas. Los técnicos de Ariete se han concentrado en la ergonomía del cuadro que se adapta perfectamente a la forma de la cara.

## HIGH TECHNOLOGY

**IT** Per realizzare le proprie maschere Ariete si avvale delle tecnologie più avanzate per la produzione di ogni singolo componente. Sofisticate attrezzature permettono di raggiungere quell'alto standard qualitativo che pone le maschere Ariete al top del mercato mondiale.

**UK** Ariete goggle frames and ancillary components are made with the best technology available. The quality of the tooling ensures that the finish achieved is exemplary.

**FR** Pour la réalisation de ses lunettes Ariete bénéficie des technologies de pointe pour la production de chaque composant. Des équipements hautement sophistiqués permettent d'atteindre les hauts standards qualitatifs qui poussent Ariete au sommet du marché mondial.

**ES** Para la realización de las propias máscaras Ariete hace uso de la tecnología más avanzada para la producción de cada componente individual. Son los equipos sofisticados los que permiten alcanzar un alto nivel de calidad ubicando las máscaras Ariete en la cúspide del mercado mundial.



## FINE MATERIALS

**IT** Le materie prime impiegate sono frutto di meticolosa ricerca da parte di Ariete presso le più prestigiose industrie petrolchimiche nei vari continenti in modo da garantire la massima qualità dei materiali impiegati che si riscontra nelle maschere Ariete.

**UK** The search for new materials is never-ending. Ariete has for years worked with the world's best-known petro-chemical companies. The materials used are the result of research carried out by these companies, and are the best we can find.

**FR** Les matières premières utilisées sont le fruit d'une recherche minutieuse de la part de Ariete auprès des plus prestigieuses industries pétrochimiques du monde pour garantir la meilleure qualité des matériaux que l'on observe dans les lunettes Ariete.

**ES** Las materias primas empleadas son fruto de una investigación minuciosa llevada a cabo por Ariete en las industrias petroquímicas de mayor prestigio en distintos continentes, de manera de asegurar la más alta calidad de los materiales aplicados en las máscaras Ariete.

## SAFETY

**IT** La lente dell'occhiale ARIETE resiste all'impatto di una sfera d'acciaio di 6 mm di diametro lanciata a 216 km/h! Il trattamento anti-fog resiste a più del doppio del minimo requisito dalla norma 168:2001.16

**UK** The ARIETE lens will withstand a 6 mm. steel ball hitting it at 135 miles per hour! The anti-fog treatment withstands more than twice the minimum requirement of standard 168: 2001.16

**FR** Les verres des lunettes ARIETE résistent à l'impact d'une sphère en acier de 6 mm de diamètre lancée à 216 km/h ! Le traitement anti-buée résiste plus que le double des exigences minimales fixées par la norme 168 :2001.16

**ES** La lente ARIETE resiste a una esfera de acero de 6mm. de diámetro que impacta a 216 km/h! El tratamiento anti-empañamiento resiste a más del doble del mínimo prescrito por la norma 168:2001.16

## CERTIFICATIONS & MARKING

**IT** L'occhiale e le lenti Ariete sono certificati secondo le norme europee EN 1938:2010; le lenti sono provviste di trattamento anti-fog che è opzionale secondo la norma europea EN 1938:2010, superano i test di impatto "High Mass" e "High velocity" secondo la norma americana ANSI Z87.1-2003 e rispondono alle caratteristiche prescritte dalla norma americana VESC-8. Sull'etichetta dell'occhiale vengono riportate le categorie di trasmissione luminosa delle lenti.

**UK** Ariete goggles and lenses are certified according to European standards EN 1938:2010; they are provided with Anti-fog treatment, which is optional under European standard EN 1938:2010; they pass the "High Mass" and "High velocity" impact tests provided for by American ANSI standard Z87.1-2003; they meet the requirements of American standard VESC-8. The label on the goggles provides the transparency categories of Ariete lenses.

**FR** La monture et les verres de Ariete sont certifiées selon les normes européennes EN 1938 :2010; les verres ont le traitement anti-buée qui est facultatif selon la norme européenne EN 1938:2010, ils ont passé les tests de résistance aux chocs "High Mass" et "High Velocity" selon la norme américaine ANSI Z87.1-2003 et répondent aux propriétés prescrites par la norme américaine VESC-8. L'étiquette des lunettes indique les catégories de transmission lumineuse des verres.

**ES** Las gafas y las lentes Ariete están certificadas conforme a las normas europeas EN 1938:2010; las lentes están provistas de tratamiento anti-empañamiento opcional en la norma europea EN 1938:2010, superan los controles de impacto "High Mass" y "High velocity" conforme a la norma americana ANSI Z87.1-2003 y responden a las características prescritas por la norma americana VESC-8. Sobre las lentes Ariete viene marcada la categoría de transmisión luminosa de las mismas.





Il Sistema di Ventilazione Ariete, utilizzando specifiche aree per l'ingresso e la fuoriuscita dell'aria, interviene direttamente sulla temperatura all'interno dell'occhiale e sfruttando il profilo frontale superiore del frame, opportunamente ribassato, facilita l'afflusso di aria alle prese di ventilazione del casco.

The Ariete Ventilation System uses carefully chosen areas for the intake and exhaust of cooling air. Airflow from the goggles, whose upper front profile is specially lowered to aid this process, enters the collecting vents at the front of the helmet, flows across the rider's head, and leaves the back of the helmet in a continuous process.

Le Système de Ventilation Ariete, en se servant des zones spécifiques pour l'entrée et la sortie de l'air, intervient directement sur la température à l'intérieur des lunettes. De plus, en exploitant le profil supérieur de la monture, dûment baissé, facilite la pénétration de l'aire dans les prises de ventilation du casque.

El Sistema de Ventilación Ariete, que tiene zonas específicas para la entrada y salida del aire, regula la temperatura del interior de las gafas y gracias al perfil frontal superior de la montura, adecuadamente rebajado, facilita la circulación del aire en las entradas de ventilación del casco.

## ARIETE VENTILATION SYSTEM

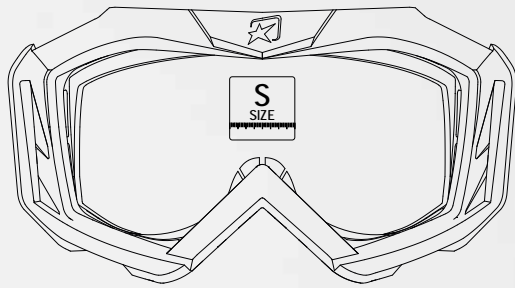

## 07 NEXT GEN

- IT** Telaio compatto con dimensioni ridotte  
Vestibilità /calzata stretta/aderente
- UK** Tight comfort  
Compact structure
- FR** Monture compacte avec dimensions reduites  
Porte/vestibilite' serree/adherente
- ES** Marco compacto de dimensiones reducidas  
Ajuste perfecto/adherente

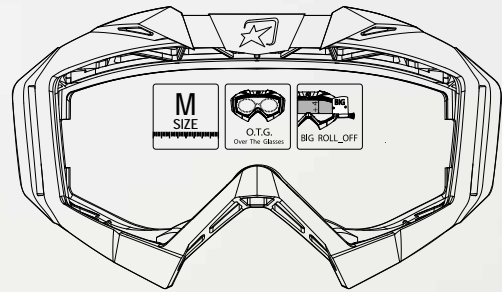

## ADRENALINE

- IT** Extra ventilazione
- UK** Extra Ventilation
- FR** Extra aeration
- ES** Extra ventilación

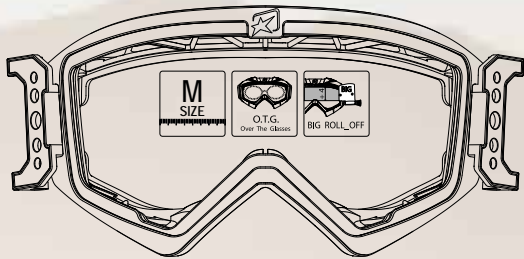

## MUDMAX

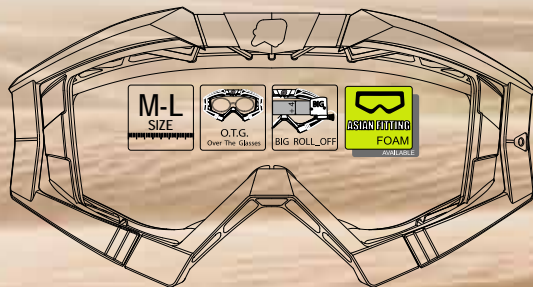

## RIDING CROWS

- IT** Spugna 3D termoformata per una miglior vestibilità  
Chele esterne per una perfetta calzata sul casco
- UK** 3D Thermoformed Foam For Improved Fit  
Adjustable Outriggers For Perfect Helmet Fit
- FR** Mousse en 3D thermoformee pour un meilleur vestibilite'  
Stabilisateurs réglables pour un vestibilite' parfait sur le casque
- ES** Espuma 3D termoformada para un mejor confort  
Garras exteriores para un ajuste perfecto en el casco

- IT Una sola lente di ricambio per tutti gli occhiali Ariete**
- ★ Protezione totale dai raggi uv
- ★ Miglior trattamento anti-appannamento disponibile sul mercato
- ★ Lenti anti-distorsione
- ★ Lenti in Lexan®
- ★ AVS Sistema di Ventilazione Ariete
- ★ Spugne ipoallergeniche a contatto con il viso
- ★ Elastici con banda in silicone anti-scivolo
- ★ Doppia fibbia per una veloce regolazione
- ★ Sicura e certificata
- ★ Made in Italy

- UK One lens fits all Ariete goggles**
- ★ UV rays total protection
- ★ Best Anti fog coating
- ★ Distortion-free lenses
- ★ Lexan® lenses
- ★ AVS Ariete Ventilation System
- ★ Hypo-allergenic foams in contact with the skin
- ★ Elastic strap with anti-slip silicone bead
- ★ Double buckle for quick adjustment
- ★ Safety and Certifications
- ★ Made in Italy

- FR Un seul verre de rechange pour toutes les lunettes Ariete**
- ★ Protection totale contre les rayons uv
- ★ Meilleur traitement anti-buée disponible sur le marché
- ★ Verres anti-distorsion d'images
- ★ Verres en Lexan®
- ★ AVS Systeme de Ventilation Ariete
- ★ Mousse hypoallergéniques en contact avec le visage
- ★ Elastiques avec bande en silicone anti-glisse
- ★ Double boucle pour un réglage rapide
- ★ Fiable et certifiée
- ★ Made in Italy

- ES Una sola lente de recambio para todas las gafas Ariete**
- ★ Protección total contra los rayos uv
- ★ El mejor tratamiento anti-vaho disponible en el mercado
- ★ Lentes anti-distorsión de imagen
- ★ Lentes de Lexan®
- ★ AVS Sistema de Ventilación Ariete
- ★ Espumas hipoalergénicas a contacto con la piel del rostro
- ★ Elásticos con banda antideslizante de silicona
- ★ Doble hebilla para ajuste rapido
- ★ Segura y certificada
- ★ Made in Italy



## GOGGLES FEATURES GUIDE

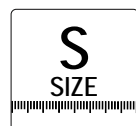

Taglia S  
Size S  
Tamaño S  
Taille S



Taglia M  
Size M  
Tamaño M  
Taille M



Taglia M-L  
Size M-L  
Tamaño M-L  
Taille M-L

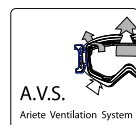

Sistema di Ventilazione Ariete  
Ariete Ventilation System  
Sistema de Ventilación Ariete  
Système de Ventilation Ariete



Impiego anche con occhiali correttivi  
Comfortably Fits Glasses  
Posibilidad de uso con gafas graduadas  
Compatible avec le port de lunettes de vue

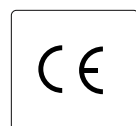

Sicura e certificata  
Safety and Certifications  
Segura y certificada  
Fiable et certifiée

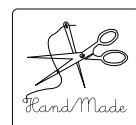

Imbottitura cucita a mano ed ognuna unica nella sua realizzazione  
Hand made padding  
Acolchado interior hecho a mano  
Rembourrage cousu main, chaque réalisation est unique



Elastico con silicone antiscivolo  
Elastic strap with anti-slip silicone  
Banda con silicona antideslizante  
Elastiques avec silicone anti-glisse

## FRAME FEATURES GUIDE

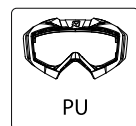

Poliuretano  
Polyurethane  
Poliuretano  
Polyuréthane

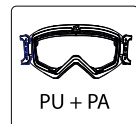

Poliuretano + Poliammide  
Polyurethane + Polyamide  
Poliuretano + Poliamida  
Polyuréthane + Polyamide

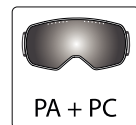

Poliammide + Policarbonato  
Polyamide + Polycarbonate  
Poliamida + Policarbonato  
Polyamide + Polycarbonate

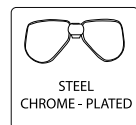

Montatura in acciaio cromato  
Steel chrome-plated frame  
Montura en acero cromado  
Monture en acier chromé

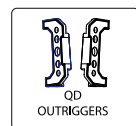

Chele esterne per una perfetta calzata sul casco  
Adjustable Outriggers For Perfect Helmet Fit  
Garras exteriores para un ajuste perfecto en el casco  
Stabilisateurs réglables pour un vestibilité parfait sur le casque



Telaio ultra leggero  
Ultra Lightweight frame  
Montura ultra ligera  
Monture ultra legere

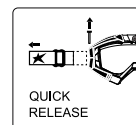

Sgancio rapido  
Quick release  
Apertura rápida  
Ouverture rapide

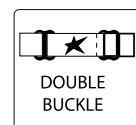

Doppia fibbia per una veloce regolazione  
Double buckle for quick adjustment  
Doble hebilla para ajuste rapido  
Double boucle pour un réglage rapide

## FOAM FEATURES GUIDE

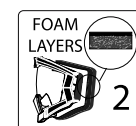

Guarnizione a 2 strati  
2 layer face foam specification  
Interior con 2 capas  
Contour à double épaisseur

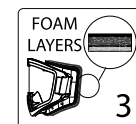

Guarnizione a 3 strati  
3 layer face foam specification  
Interior con 3 capas  
Contour à triple épaisseur



Strato di CARBON X ipoallergenico rosso  
Layer of red hypo-allergenic CARBON X  
Capa de tejido CARBON X hipoalergénico rojo  
Couche de CARBON X hypoallergénique rouge

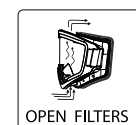

Filtri aperti  
Open filters  
Filtros abiertos  
Filtres ouverts

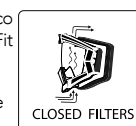

Filtri chiusi  
Closed filters  
Filtros cerrados  
Filtres fermés



Spugna maggiorata  
Extra-thick foam  
Espuma aumentada  
Mousse accrue



Disponibile versione per visi asiatici  
Asian fitting foam version available  
Disponibile versión para fisonomía asiática  
Disponibile dans la version pour visages asiatiques



Spugna termoformata in 3D  
3D thermoformed foam  
3D termoformada  
Mousse thermoformée en 3D

## LENSES FEATURES GUIDE



Protezione totale dai raggi uv  
UV rays total protection  
Protección total contra los rayos uv  
Protection totale contre les rayons uv



Miglior trattamento anti-appannamento  
Best Anti fog coating  
El mejor tratamiento anti-vaho  
Meilleur traitement anti-buee



Trattamento anti graffio  
Anti-scratch treatment  
Tratamiento anti-rayado  
Traitement anti-rayure



Lente sferica  
Spherical lens  
Lente esférica  
Verre sphérique



Lente fotocromatica cat.0→1  
Photochromic lens cat.0→1  
Lente fotocromática cat.0→1  
Verre photochromique cat. 0→1



Lente doppia, cilindrica, ventilata  
Double, cylindrical, ventilated lens  
Lente transparente doble, cilíndrica, ventilada  
Verre double, cylindrique, ventilé

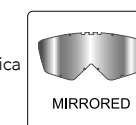

Lente specchiata multistrato cat. 2  
Mirrored multi-layer lens cat.2  
Lente de espejo multicapa cat.2  
Verre effet miroir cat. 2



Lente "Plus" fumé specchiata cat. 1  
Mirrored smoked lens "Plus" cat. 1  
Lente de espejo ahumada "Plus" cat. 1  
Verre "Plus" fumé effet miroir cat. 1

### IT Traspirante e termoregolatore - Antistatico - Batteriostatico - Performante - Naturale - Schermante

- Traspirante e termoregolatore - Accelera il processo di evaporazione del sudore, rallenta la formazione di umidità sulla pelle e mantiene costante la temperatura.
- Antistatico - Le sue speciali fibre conduttive assorbono e disperdono le cariche elettriche accumulate dall'ambiente esterno o durante l'attività fisica.
- Batteriostatico - Rispetta la pelle e la protegge da batteri e polveri inquinanti, eliminando il rischio di fastidiose allergie.
- Performante - Durante l'attività fisica diminuisce la concentrazione di acido lattico, migliorando la circolazione sanguigna e l'ossigenazione delle cellule.
- Naturale - Naturale al 100%, non tossico e non contiene prodotti chimici.
- Schermante - Protegge il corpo dall'assorbimento di energia statica, dall'elettrosmog e dai raggi UV.

### UK Antistatic - Bacteriostatic - Heat regulating and moisture transfer - Natural - Reflective

- High Performance
- Heat regulating and moisture transfer - Speeds up the evaporation process of perspiration and slows down the formation of humidity on the skin to help keep the temperature constant.
- Antistatic - Reacting to natural conductivity in nature, the fiber absorbs and disperses electric charges accumulated from the environment or during physical exercise, to prevent shock and the attraction of dust particles to the product.
- Bacteriostatic - Protects the skin from bacteria and pollutant dusts, eliminating the risk of annoying allergies.
- Natural - 100% natural, non-toxic and does not contain chemicals.
- Reflective - Protects the body from absorbing static energy, electrosmog, and UV rays.

### FR Respirant et thermorégulateur - Antistatique - Bactériostatique - Performant - Naturel - Effet écran

- Respirant et thermorégulateur - Pour accélérer l'évaporation de la sueur, et ralentir la formation d'humidité sur la peau, tout en gardant la température constante.
- Antistatique - Ses spéciales fibres conductrices absorbent et dispersent les charges électriques cumulée dans l'environnement extérieur ou durant l'activité physique.
- Bactériostatique - Pour respecter la peau et la protéger des bactéries et des poussières polluantes, éliminant tout risque d'allergies dérangeantes.
- Performant - Durant l'activité physique, baisse la concentration d'acide lactique tout en améliorant la circulation sanguine et l'oxygène des cellules.
- Naturel - Naturel à 100%, non toxique et sans produits chimiques.
- Effet écran - Il protège le corps contre l'absorption d'énergie statique, d'électrosmog et des rayons UV.

### ES Transpirante y termoregulador - Antiestático - Bacteriostático - Rendimiento - Natural - Protector

- Transpirante y termoregulador - Acelera el proceso de evaporación del sudor, disminuye la formación de humedad en la piel y mantiene constante la temperatura.
- Antiestático - Sus especiales fibras conductoras, absorben y dispersan las cargas eléctricas acumuladas en el ambiente exterior o durante la actividad física.
- Bacteriostático - Respeta la piel y la protege de bacterias y polvos contaminantes, mejorando el riesgo de fastidiosas alergias.
- Rendimiento - Durante la actividad física disminuye la concentración de ácido láctico, mejorando la circulación sanguínea y la oxigenación de las células.
- Natural - Natural al 100%, no es tóxico y no contiene productos químicos.
- Protector - Protege el cuerpo de la absorción de energía estática, del electrosmog y de los rayos UV.



## HIGH PERFORMANCE



Traspirante e termoregolatore  
Heat regulating and moisture transfer  
Respirant et thermorégulateur  
Transpirante y termoregulador



Performante  
Performance  
Performant  
Rendimiento



Antistatico  
Antistatic  
Antistatique  
Antiestático



Naturale  
Natural  
Naturel  
Natural



Batteriostatico  
Bacteriostatic  
Bactériostatique  
Bacteriostático



Schermante  
Reflective  
Effet écran  
Protector



Tommaso Montanari - Photo C. Morello



## IT

**1 TELAIO**

- Taglia Media
- Campo di visione ampliato sul bordo inferiore, ottimizzato per le discese
- Impiego anche con occhiali correttivi (O.T.G.)
- Materiale poliuretano flessibile anche a basse temperature
- Colori anti-UV
- Compatible con il Kit BIG/XL Roll-Off 12962-RCRO

**2LENTE**

- Lente multistrato specchiata cat. 2
- Nessuna distorsione ottica
- Miglior trattamento anti-appannamento
- Protezione totale dai raggi UV

**3VENTILAZIONE**

- A.V.S. Sistema di Ventilazione Ariete
- Ventilazione maggiorata
- Filtri aperti

**4 SPUGNE**

- Guarnizione a 3 strati composta da:
  - 1° strato composto da una spugna tecnica a cellule chiuse
  - 2° strato composto da una spugna tecnica supersoft a cellule aperte
  - 3° strato composto da uno strato di CARBON X ipoallergenico rosso a contatto con la pelle

**5 ELASTICO**

- Elastico h. 45 mm con silicone antiscivolo
- Clip laterale per aggancio lenti a strappo/tear-off
- Doppia fibbia per una veloce regolazione

**ACCESSORI INCLUSI**

- Lente chiara certificata CE cod.12961-RCCH in Lexan® con trattamento anti graffio completa di clips
- Custodia in microfibra con tasca interna per una lente di ricambio.

## FR

**1 MONTURE**

- Taille Moyenne
- Champ de vision agrandi sur le bord inférieur, optimisé pour les pentes
- Compatible avec le port de lunettes de vue (O.T.G.)
- Matériau polyuréthane flexible même à basses températures
- Coloris anti-UV
- Compatible avec le Kit Roll-Off version BIG/XL 12962-RCRO

**2 VERRE**

- Verre effet miroir cat. 2
- Verre anti distorsion optique
- Meilleur traitement antibuée
- Protection totale des rayons UV

**3 VENTILATION**

- A.V.S. Système de Ventilation Ariete
- Ventilation accrue
- Filtres ouverts

**4 MOUSSES**

- Contour à triple épaisseur composé par:
  - 1ère couche de mousse techniques à cellules fermées
  - 2ème couche de mousse technique ultra douce à cellules ouvertes
  - 3ème couche de CARBON X hypoallergenique rouge contact avec la peau

**5 ELASTIQUE**

- Elastique h. 45 mm avec silicone antiglisse
- Clip latérale pour accrochage des verres lentilles amovibles/tear-off
- Double boucle pour un réglage rapide

**ACCESSOIRES INCLUS**

- Verre clair certifié CE code 12961-RCCH en Lexan® avec traitement anti-rayure équipé de clips
- Housse en microfibre avec poche interne pour verre de rechange

## UK

**1 FRAME**

- Medium Fit
- Enhanced vision field on the lower lens for downhill riding
- Comfortably Fits Glasses (O.T.G.)
- Tough PUR frame for low-temperature flexibility
- Anti-UV colours
- Compatible with BIG/XL Roll-Off Kit 12962-RCRO

**2 LENS**

- Mirrored multi-layer lens cat.2
- No optical distortion
- Best anti-fog treatment
- UV radiations total protection

**3 VENT SYSTEM**

- A.V.S. Ariete Ventilation System
- Extra Ventilation
- Open filters

**4 FOAM**

- Three-layer face foam specification composed of :
  - 1st layer is technical foam with closed cells
  - 2nd layer is super-soft technical foam with open cells
  - 3rd layer of red hypo-allergenic CARBON X in contact with the skin

**5 ELASTIC STRAP**

- 45 mm height elastic strap with anti-slip silicone
- Pin to suit tear-off
- Double buckle for quick adjustment

**INCLUDED ACCESSORIES**

- Lexan® clear lens, CE, anti-scratch treatment, cod.12961-RCCH equipped with clips
- Microfibre bag with internal pocket for a spare lens

## ES

**1 ESTRUCTURA**

- Talla Media
- Campo de visión aumentado en el borde inferior especialmente indicado para la conducción en descenso
- Posibilidad de uso con gafas graduadas (OTG)
- Elaborada en poliuretano elástico fuerte y flexible a bajas temperaturas
- Colores anti UV
- Compatible con el Kit BIG/XL Roll-Off 12962-RCRO

**2LENTE**

- Lente de espejo multicapa cat.2
- Sin distorsión óptica
- Mejor tratamiento anti-empañamiento
- Protección total contra los rayos UV

**3 VENTILACIÓN**

- A.V.S. Sistema de Ventilación Ariete
- Ventilación extra
- Filtros abiertos

**4 ESPUMA**

- Especificación facial de tres capas compuesta de:
  - 1 capa de espuma técnica con células cerradas
  - 1 capa de espuma técnica súper suave con células abiertas
  - 1 capa de tejido CARBON X hipoalergénico de color rojo en contacto con la piel

**5 ELÁSTICO**

- Banda de 45 mm de altura con silicona antideslizante
- Clip para instalación tirables/tear-off
- Doble hebilla para un ajuste rápido

**ACCESORIOS INCLUIDOS**

- Lente transparente en Lexan®, CE, con tratamiento anti-rayado cod.12961-RCCH equipada con clips
- Bolsa de microfibra con bolsillo interno para una lente de repuesto



14940-BSG

€ 90,00 + IVA/VAT

CAT. 2



14940-BAA

€ 90,00 + IVA/VAT

CAT. 2



14940-BRR

€ 90,00 + IVA/VAT

CAT. 2



14940-BVN

€ 90,00 + IVA/VAT

CAT. 2



14940-BCG

€ 60,00 + IVA/VAT

CAT. 0



14940-BSB

€ 60,00 + IVA/VAT

CAT. 0



FEATURES

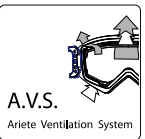

A.V.S.  
Ariete Ventilation System



O.T.G.  
Over The Glasses



UV FILTERS



ANTI\_FOG

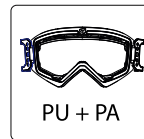

PU + PA

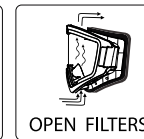

OPEN FILTERS

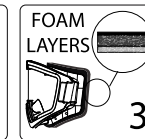

FOAM LAYERS  
3

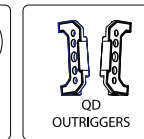

QD  
OUTRIGGERS

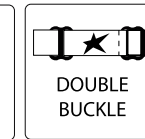

DOUBLE  
BUCKLE

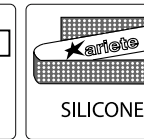

SILICONE

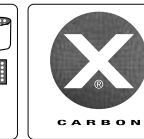

CARBON

INCLUDED



LENS  
12961-RCCH



ANTI\_SCRATCH

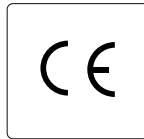

CE



MICROFIBRE  
BAG

OPTIONAL



One Size Fits All  
ARIETE LENS

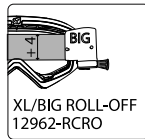

XL/BIG ROLL-OFF  
12962-RCRO



STANDARD  
TEAR-OFF  
12964-MMLE





14940-NSG

€ 90,00 + IVA/VAT

CAT. 2



SINGLE



14940-NRR

€ 90,00 + IVA/VAT

CAT. 2



SINGLE



14940-NAA

€ 90,00 + IVA/VAT

CAT. 2



SINGLE



14940-NVN

€ 90,00 + IVA/VAT

CAT. 2



SINGLE



14940-NCN

€ 60,00 + IVA/VAT

CAT. 0



SINGLE



14940-NSN

€ 60,00 + IVA/VAT

CAT. 0



SINGLE

FEATURES

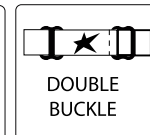
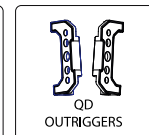
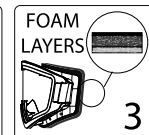
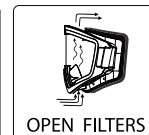
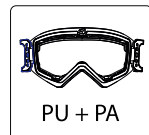
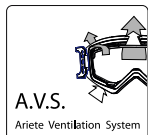

INCLUDED

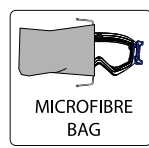
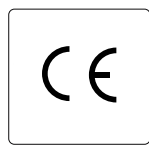

OPTIONAL

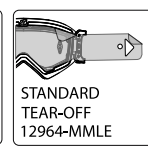
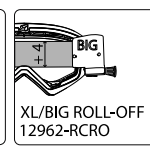



14940-BDV € 65,00 + IVA/VAT

CAT. 0 DOUBLE



14940-BDO € 65,00 + IVA/VAT

CAT. 1 DOUBLE



14940-BDA € 65,00 + IVA/VAT

CAT. 1 DOUBLE



14940-NDV € 65,00 + IVA/VAT

CAT. 0 DOUBLE



14940-NDO € 65,00 + IVA/VAT

CAT. 1 DOUBLE



14940-NDG € 65,00 + IVA/VAT

CAT. 1 DOUBLE

FEATURES

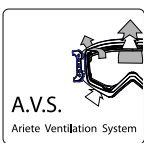

A.V.S.  
Ariete Ventilation System



O.T.G.  
Over The Glasses

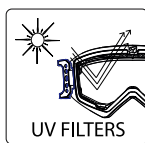

UV FILTERS



ANTI\_FOG

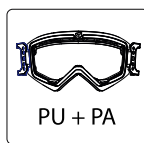

PU + PA

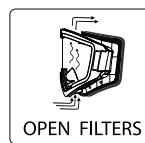

OPEN FILTERS

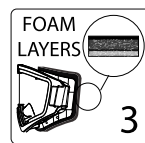

FOAM LAYERS  
3

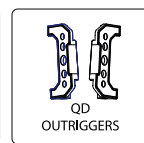

QD  
OUTRIGGERS

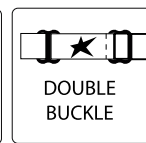

DOUBLE  
BUCKLE



SILICONE



CARBON

FEATURES



ANTI\_SCRATCH

OPTIONAL



One Size Fits All  
ARIETE LENS

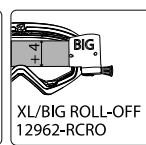

XL/BIG ROLL-OFF  
12962-RCRO

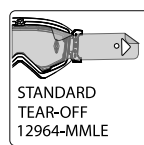

STANDARD  
TEAR-OFF  
12964-MMLE









14940-NAV

€ 90,00 + IVA/VAT

CAT. 0 



SINGLE



FEATURES

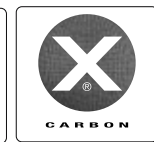
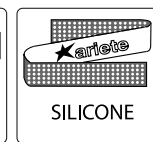
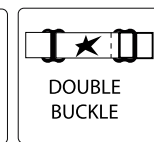
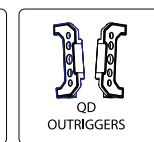
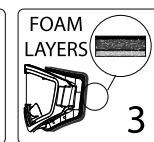
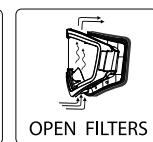
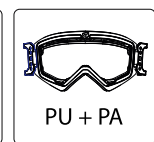
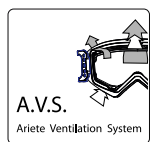

FEATURES

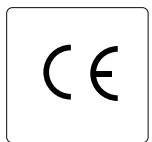

INCLUDED



OPTIONAL

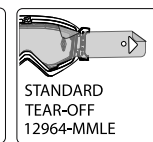
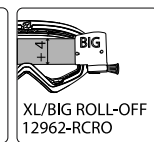





MUDMAX EASY

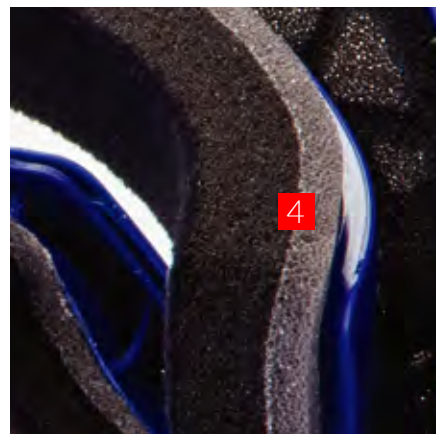
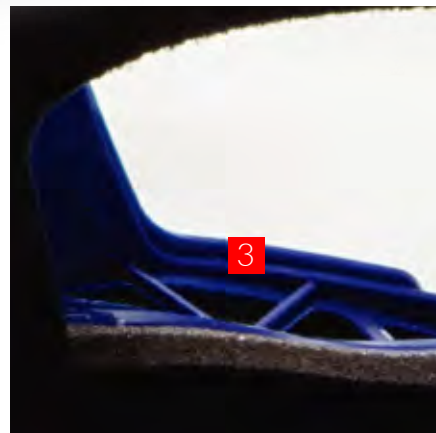

## IT

**1** TELAIO

- Taglia Media
- Campo di visione ampliato sul bordo inferiore, ottimizzato per le discese
- Impiego anche con occhiali correttivi (O.T.G.)
- Materiale poliuretano flessibile anche a basse temperature
- Colori anti-UV
- Compatibile con il Kit BIG/XL Roll-Off 12962-RCRO
- Certificata CE

**2**LENTE

- Lente chiara in Lexan® cod. 12961-SCCH
- Nessuna distorsione ottica
- Miglior trattamento anti-appannamento
- Trattamento anti graffio
- Protezione totale dai raggi UV

**3**VENTILAZIONE

- A.V.S. Sistema di Ventilazione Ariete
- Ventilazione maggiorata
- Filtri aperti

**4**SPUGNE

- Guarnizione a 3 strati composta da:
  - 1 strato di spugna tecnica super soft a cellule aperte
  - 1 strato di spugna a media densità
  - 1 strato di pile ipoallergenico a contatto con la pelle

**5**ELASTICO

- Elastico h. 40 mm con silicone antiscivolo
- Clip laterale per aggancio lenti a strappo/tear-off
- Doppia fibbia per una veloce regolazione

## FR

**1** MONTURE

- Taille Moyenne
- Champ de vision agrandi sur le bord inférieur, optimisé pour les pentes
- Compatible avec le port de lunettes de vue (O.T.G.)
- Matériau polyuréthane flexible même à basses températures
- Coloris anti-UV
- Compatible avec le Kit Roll-Off version BIG/XL 12962-RCRO
- Certifiée CE

**2**VERRE

- Verre clair en Lexan® code 12961-SCCH
- Verre anti distorsion optique
- Meilleur traitement antibuée
- Traitement anti-rayure
- Protection totale des rayons UV

**3**VENTILATION

- A.V.S. Système de Ventilation Ariete
- Ventilation accrue
- Filtres ouverts

**4**MOUSSES

- Contour à triple épaisseur composé par:
  - 1 couche de mousse technique ultra douce à cellules ouvertes
  - 1 couche de mousse à densité moyenne
  - 1 couche en polaire noire anti allergique en contact avec la peau

**5**ELASTIQUE

- Elastique h. 40 mm avec silicone antiglisse
- Clip latérale pour accrochage des verres lentilles amovibles/tear-off
- Double boucle pour un réglage rapide

## UK

**1**FRAME

- Medium Fit
- Enhanced vision field on the lower lens for downhill riding
- Comfortably Fits Glasses (O.T.G.)
- Tough PUR frame for low-temperature flexibility
- Anti-UV colours
- Compatible with BIG/XL Roll-Off Kit 12962-RCRO
- CE approved

**2**LENS

- Lexan® clear lens cod. 12961-SCCH
- No optical distortion
- Best anti-fog treatment
- Anti-scratch treatment
- UV radiations total protection

**3**VENT SYSTEM

- A.V.S. Ariete Ventilation System
- Extra Ventilation
- Open filters

**4**FOAM

- Three-layer face foam specification composed of :
  - 1 super-soft technical foam layer with open cells
  - 1 medium density foam layer
  - 1 hypo-allergenic foam layer in contact with the skin

**5**ELASTIC STRAP

- 40 mm height elastic strap with anti-slip silicone
- Pin to suit tear-off
- Double buckle for quick adjustment

## ES

**1**ESTRUCTURA

- Talla Media
- Campo de visión aumentado en el borde inferior especialmente indicado para la conducción en descenso
- Posibilidad de uso con gafas graduadas (OTG)
- Elaborada en poliuretano elástico fuerte y flexible a bajas temperaturas
- Colores anti UV
- Compatible con el Kit BIG/XL Roll-Off 12962-RCRO
- Certificación CE

**2**LENTE

- Lente transparente en Lexan® cod. 12961-SCCH
- Sin distorsión óptica
- Mejor tratamiento anti-empañamiento
- Tratamiento anti-rayado
- Protección total contra los rayos UV

**3**VENTILACIÓN

- A.V.S. Sistema de Ventilación Ariete
- Ventilación extra
- Filtros abiertos

**4**ESPUMA

- Especificación facial de tres capas compuesta de:
  - 1 capa de espuma técnica súper suave con células abiertas
  - 1 capa de espuma de densidad media
  - 1 capa de tejido hipoalergénico en contacto con la piel

**5**ELÁSTICO

- Banda de 40 mm de altura con silicona antideslizante
- Clip para instalación tirables/tear-off
- Doble hebilla para un ajuste rápido



14940-ENNG

€ 42,00 + IVA/VAT

CAT. 0



SINGLE



14940-EABA

€ 42,00 + IVA/VAT

CAT. 0



SINGLE



14940-EBBP

€ 42,00 + IVA/VAT

CAT. 0



SINGLE



14940-ENNR

€ 42,00 + IVA/VAT

CAT. 0

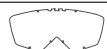

SINGLE



14940-EBBV

€ 42,00 + IVA/VAT

CAT. 0

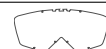

SINGLE



14940-ENGO

€ 42,00 + IVA/VAT

CAT. 0



SINGLE

FEATURES

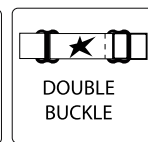
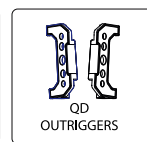
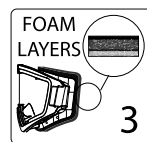
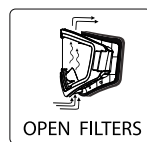
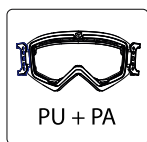
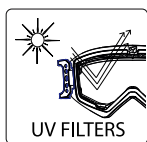
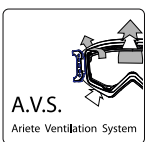

FEATURES

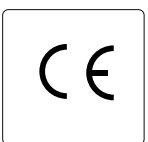

OPTIONAL

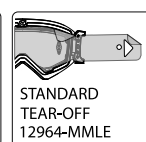
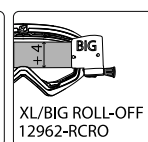
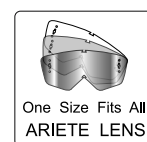



Angelo Enduroblogger-Photo L. Refrigeri Photography



ADRENALINE PRIMIS PLUS

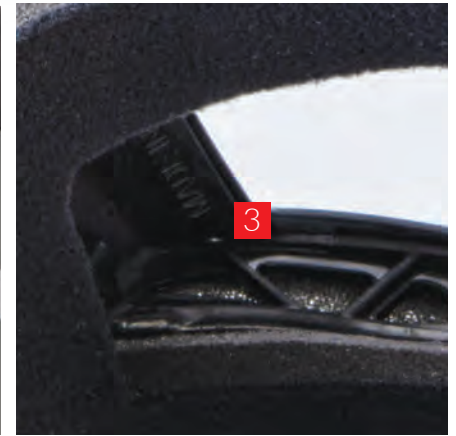

## IT

### 1 TELAIO

- Taglia Media
- Impiego anche con occhiali correttivi (O.T.G.)
- Compatibile con il Kit BIG/XL Roll-Off cod. 12962-RCRO
- Materiale poliuretano flessibile anche a basse temperature
- Colori anti-UV
- Certificata CE

### 2 LENTE

- Lente "Plus" fumé specchiata cat. 1 cod.12961-SCPL
- Nessuna distorsione ottica
- Miglior trattamento Anti-appannamento
- Protezione totale dai raggi UV

### 3 VENTILAZIONE

- A.V.S. Sistema di Ventilazione Ariete
- Ventilazione maggiorata
- Filtri aperti

### 4 SPUGNE

- Guarnizione a 3 strati composta da:
  - 1 strato di spugna tecnica super soft a cellule aperte
  - 1 strato di spugna a media densità
  - 1 strato di pile ipoallergenico a contatto con la pelle

### 5 ELASTICO

- Elastico con silicone antiscivolo
- Clip laterale per aggancio lente a strappo/tear-off cod. 12964-RCLE
- Doppia fibbia per regolazione

## FR

### 1 MONTURE

- Taille Moyenne
- Compatible avec le port de lunettes de vue (O.T.G.)
- Compatible avec le Kit BIG/XL Roll-Off code 12962-RCRO
- Matériau polyuréthane flexible même à basses températures
- Coloris anti-UV
- Certifiée CE

### 2 VERRE

- Verre "Plus" fumé effet miroir cat. 1 cod.12961-SCPL
- Verre anti distorsion optique
- Meilleur traitement antibuée
- Protection totale des rayons UV

### 3 VENTILATION

- A.V.S. Système de Ventilation Ariete
- Ventilation accrue
- Filtres ouverts

### 4 MOUSSES

- Contour à triple épaisseur composé par:
  - 1 couche de mousse technique ultra douce à cellules ouvertes
  - 1 couche de mousse à densité moyenne
  - 1 couche en polaire noire anti allergique en contact avec la peau

### 5 ELASTIQUE

- Elastique avec silicone antiglisse
- Clip latérale pour accrocher les verres lentilles amovibles /tear-off code 12964-RCLE
- Double boucle de réglage

## UK

### 1 FRAME

- Medium Fit
- Comfortably Fits Glasses (O.T.G.)
- Compatible with BIG/XL Roll-Off Kit cod. 12962-RCRO
- Tough PUR frame for low-temperature flexibility
- Anti - UV colours
- CE approved

### 2 LENS

- Mirrored smoked lens "Plus" cat. 1 cod.12961-SCPL
- No optical distortion
- Best anti-fog treatment
- UV radiations total protection

### 3 VENT SYSTEM

- A.V.S. Ariete Ventilation System
- Extra Ventilation
- Open filters

### 4 FOAM

- Three-layer face foam specification composed of :
  - 1 super-soft technical foam layer with open cells
  - 1 medium density foam layer
  - 1 hypo-allergenic foam layer in contact with the skin

### 5 ELASTIC STRAP

- Elastic strap with anti-slip silicone
- Pin to suit tear-off cod. 12964-RCLE
- Double buckle for quick adjustment

## ES

### 1 ESTRUCTURA

- Talla Media
- Posibilidad de uso con gafas graduadas (OTG)
- Compatible con el Kit BIG/XL Roll-Off cod. 12962-RCRO
- Elaborada en poliuretano elástico fuerte y flexible a bajas temperaturas
- Colores anti UV
- Certificación CE

### 2 LENTE

- Lente de espejo ahumada "Plus" cat. 1 cod.12961-SCPL
- Sin distorsión óptica
- Mejor tratamiento anti-empañamiento
- Protección total contra rayos UV

### 3 VENTILACIÓN

- A.V.S. Sistema de Ventilación Ariete
- Ventilación extra
- Filtros abiertos

### 4 ESPUMA

- Especificación facial de tres capas compuesta de:
  - 1 capa de espuma técnica súper suave con células abiertas
  - 1 capa de espuma de densidad media
  - 1 capa de tejido hipoalergénico en contacto con la piel

### 5 ELÁSTICO

- Banda con silicona antideslizante
- Clip para instalación tearoff cod. 12964-RCLE
- Doble hebilla para un ajuste rápido





14001-APGF

€ 47,<sup>50</sup> + IVA/VAT

CAT. 1



SINGLE



14001-APGO

€ 47,<sup>50</sup> + IVA/VAT

CAT. 1

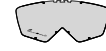

SINGLE



14001-APPA

€ 47,<sup>50</sup> + IVA/VAT

CAT. 1



SINGLE



14001-APPB

€ 47,<sup>50</sup> + IVA/VAT

CAT. 1



SINGLE



14001-APPO

€ 47,<sup>50</sup> + IVA/VAT

CAT. 1



SINGLE



14001-APPR

€ 47,<sup>50</sup> + IVA/VAT

CAT. 1



SINGLE

FEATURES

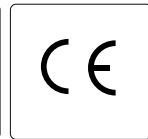
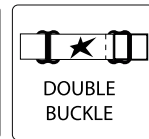
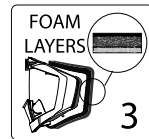
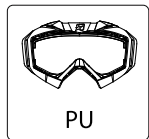
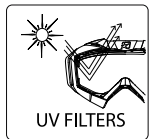
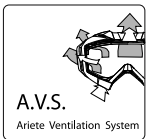

OPTIONAL

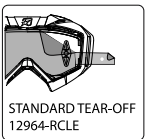
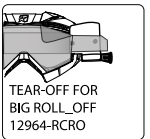
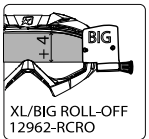

Danilo Petrucci - Photo A. Farinelli



Aimone Dal Pozzo d'Annone - Photo S. Bauerschmidt



# ADRENALINE PROFI PLUS



## IT

### 1 TELAIO

- Taglia Media
- Impiego anche con occhiali correttivi (O.T.G.)
- Compatibile con il Kit BIG/XL Roll-Off cod. 12962-RCRO
- Materiale poliuretano flessibile anche a basse temperature
- Colori anti-UV
- Certificata CE

### 2 LENTE

- Lente "Plus" fumé specchiata cat. 1 cod. 12961-SCPL
- Nessuna distorsione ottica
- Miglior trattamento Anti-appannamento
- Protezione totale dai raggi UV

### 3 VENTILAZIONE

- A.V.S. Sistema di Ventilazione Ariete
- Ventilazione maggiorata
- Filtri aperti

### 4 SPUGNE

- Guarnizione a 3 strati composta da:
  - 1° strato composto da una spugna tecnica a cellule chiuse
  - 2° strato composto da una spugna tecnica supersoft a cellule aperte
  - 3° strato composto da uno strato di CARBON X ipoallergenico in colore rosso a contatto con la pelle

### 5 ELASTICO

- Elastico con silicone antiscivolo
- Clip laterale per aggancio lente a strappo/tear-off Cod.12964-RCLE
- Doppia fibbia per regolazione

### ACCESSORI INCLUSI

- Una Lente chiara cod.12961-RCCH in Lexan® completa di clips
- Custodia in microfibra con tasca interna per una lente di ricambio

## FR

### 1 MONTURE

- Taille Moyenne
- Compatible avec le port de lunettes de vue (O.T.G.)
- Compatible avec le Kit BIG/XL Roll-Off code 12962-RCRO
- Matériau polyuréthane flexible même à basses températures
- Coloris anti-UV
- Certifiée CE

### 2 VERRE

- Verre "Plus" fumé effet miroir cat. 1 cod.12961-SCPL
- Verre anti distorsion optique
- Meilleur traitement antibuée
- Protection totale des rayons UV

### 3 VENTILATION

- A.V.S. Système de Ventilation Ariete
- Ventilation accrue
- Filtres ouverts

### 4 MOUSSES

- Contour à triple épaisseur composé par:
  - 1ère couche de mousse technique à cellules fermées
  - 2ème couche de mousse technique ultra douce à cellules ouvertes
  - 3ème couche de CARBON X anti allergique rouge en contact avec la peau

### 5 ELASTIQUE

- Elastique avec silicone antiglisse
- Clip latérale pour accrocher les verres lentilles amovibles /tear-off code 12964-RCLE
- Double boucle de réglage

### ACCESSOIRES INCLUS

- Verre clair en Lexan® code 12961-RCCH équipé de clips
- Housse en microfibre avec poche interne pour verre de rechange

## UK

### 1 FRAME

- Medium Fit
- Comfortably Fits Glasses (O.T.G.)
- Compatible with BIG/XL Roll-Off Kit cod. 12962-RCRO
- Tough PUR frame for low-temperature flexibility
- Anti - UV colours
- CE approved

### 2 LENS

- Mirrored smoked lens "Plus" cat. 1 cod.12961-SCPL
- No optical distortion
- Best anti-fog treatment
- UV radiations total protection

### 3 VENT SYSTEM

- A.V.S. Ariete Ventilation System
- Extra Ventilation
- Open filters

### 4 FOAM

- Three-layer face foam specification composed of:
  - 1st layer is technical foam with closed cells
  - 2nd layer is super-soft technical foam with open cells
  - 3rd layer of red hypo-allergenic CARBON X in contact with the skin

### 5 ELASTIC STRAP

- Elastic strap with anti-slip silicone
- Pin to suit tear-off cod. 12964-RCLE
- Double buckle for quick adjustment

### INCLUDED ACCESSORIES

- Lexan® Clear Lens cod.12961-RCCH equipped with clips
- Microfibre bag with internal pocket for a spare lens

## ES

### 1 ESTRUCTURA

- Talla Media
- Posibilidad de uso con gafas graduadas (OTG)
- Compatible con el Kit BIG/XL Roll-Off cod. 12962-RCRO
- Elaborada en poliuretano elástico fuerte y flexible a bajas temperaturas
- Colores anti UV
- Certificación CE

### 2 LENTE

- Lente de espejo ahumada "Plus" cat. 1 cod.12961-SCPL
- Sin distorsión óptica
- Mejor tratamiento anti-empañamiento
- Protección total contra los rayos UV

### 3 VENTILACIÓN

- A.V.S. Sistema de Ventilación Ariete
- Ventilación extra
- Filtros abiertos

### 4 ESPUMA

- Especificación facial de tres capas compuest de:
  - 1 capa de espuma técnica súper suave con células abiertas
  - 1 capa de espuma de densidad media
  - 1 capa de tejido CARBON X anti-alérgico de color rojo en contacto con la piel

### 5 ELÁSTICO

- Banda con silicona antideslizante
- Clip para instalación tear off cod. 12964-RCLE
- Doble hebilla para un ajuste rápido

### ACCESORIOS INCLUIDOS

- Lente transparente en Lexan® cod.12961-RCCH equipada con clips
- Bolsa de microfibra con bolsillo interno para una lente de repuesto



14001-PARA

€ 62,<sup>50</sup> + IVA/VAT

CAT.1



SINGLE



14001-PRRA

€ 62,<sup>50</sup> + IVA/VAT

CAT.1



SINGLE



14001-PBRA

€ 62,<sup>50</sup> + IVA/VAT

CAT.1



SINGLE



14001-PNGF

€ 62,<sup>50</sup> + IVA/VAT

CAT.1



SINGLE



14001-PBGF

€ 62,<sup>50</sup> + IVA/VAT

CAT.1



SINGLE



14001-PGRO

€ 62,<sup>50</sup> + IVA/VAT

CAT.1



SINGLE

FEATURES

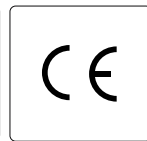
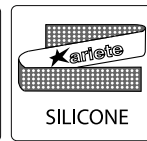
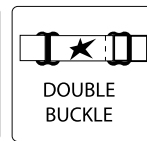
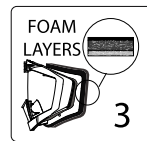
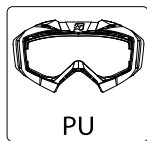
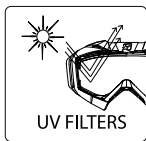
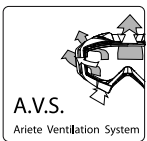

INCLUDED



OPTIONAL

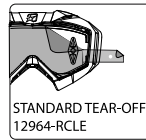
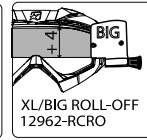
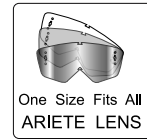



Kevin Horgmo - Photo JP Acevedo / CreyMert Racing





# RC FLOW



2



1



3



5



4

## IT

### 1 TELAIO

- Taglia media/grande
- Materiale poliuretano flessibile anche a basse temperature
- Colori anti UV
- Logo in metallo smaltato
- Chele x elastico fissate radialmente alla montatura x fitting ottimale
- Impiego anche con occhiali correttivi (OTG)
- Compatibile con il Kit BIG/XL Roll-Off cod. 12962-RCRO

### 2 LENTE

- Chiara in Lexan® doppia, cilindrica, ventilata cod. 12961-DCV
- Miglior trattamento anti appannamento
- Trattamento anti graffio
- Nessuna distorsione ottica
- Protezione totale dalle radiazioni UV

### 3 VENTILAZIONE

- A.V.S. Sistema di Ventilazione Ariete
- Ventilazione maggiorata
- Filtri aperti

### 4 SPUGNE

- Spugna termoformata in 3D per dare un comfort eccezionale
- Guarnizione a 2 strati composta da:
  - 1 strato di spugna tecnica super soft a cellule aperte
  - 1 strato di pile ipoallergenico nero a contatto con la pelle
- Disponibile versione per visi asiatici (ASIAN FITTING FOAM)

### 5 ELASTICO

- Elastico con 1 linea di silicone antiscivolo
- Doppia fibbia per regolazione

## FR

### 1 MONTURE

- Taille moyenne/grande
- Matériau polyuréthane flexible même à basses températures
- Coloris anti-UV
- Logo en métal émaillé
- Pins de fixation de l'élastique placés radialement à la monture pour un ajustement optimal
- Compatible avec le port de lunettes de vue (O.T.G.)
- Compatible avec le Kit BIG/XL Roll-Off code 12962-RCRO

### 2 VERRE

- Clair en Lexan® double, cylindrique, ventilé code 12961-DCV
- Meilleur traitement antibuée
- Traitement anti-rayure
- Verre anti distorsion optique
- Protection totale des rayons UV

### 3 VENTILATION

- A.V.S. Système de Ventilation Ariete
- Ventilation accrue
- Filtres ouverts

### 4 MOUSSES

- Mousse thermoformée en 3D pour un confort exceptionnel
- Contour à double épaisseur composé par:
  - 1 couche de mousse technique ultra douce à cellules ouvertes
  - 1 couche en polaire noire anti allergique en contact avec la peau
- Disponible dans la version pour visages asiatiques (ASIAN FITTING FOAM)

### 5 ELASTIQUE

- Elastique avec 1 bande en silicone antiglisse
- Double boucle de réglage

## UK

### 1 FRAME

- Medium/Large Fit
- Tough PUR frame for low-temperature flexibility
- Anti - UV colours
- Logo in lacquered metal
- Adjustable outriggers for perfect helmet fit
- Comfortably Fits Glasses (O.T.G.)
- Compatible with BIG/XL Roll-Off Kit cod. 12962-RCRO

### 2 LENS

- Lexan® double, cylindrical and ventilated clear lens cod. 12961-DCV
- Best anti-fog treatment
- Anti-scratch treatment
- No optical distortion
- UV radiations total protection

### 3 VENT SYSTEM

- A.V.S. Ariete Ventilation System
- Extra Ventilation
- Open filters

### 4 FOAM

- 3D thermoformed foam
- 2 layer face foam specification composed of:
  - 1 super-soft technical foam layer with open cells
  - 1 hypo-allergenic foam layer in contact with the skin
- Asian fitting foam version available

### 5 ELASTIC STRAP

- Elastic strap with 1 anti-slip silicone bead
- Double buckle for quick adjustment

## ES

### 1 ESTRUCTURA

- Talla Media / Grande
- Elaborada en poliuretano elástico fuerte y flexible a bajas temperaturas
- Colores anti UV
- Logo en metal esmaltado
- Garras para la tracción del elástico
- Posibilidad de uso con gafas graduadas (OTG)
- Compatible con el Kit BIG/XL Roll-Off cod. 12962-RCRO

### 2 LENTE

- Lente transparente doble, cilíndrica y ventilada en Lexan® cod. 12961-DCV
- Mejor tratamiento anti-empañamiento
- Tratamiento anti-rayado
- Sin distorsión óptica
- Protección total contra los rayos UV

### 3 VENTILACIÓN

- A.V.S. Sistema de Ventilación Ariete
- Ventilación extra
- Filtros abiertos

### 4 ESPUMA

- 3D termoformada para una perfecta ergonomía y adaptación a la cara
- Interior con 2 capas compuesta de:
  - 1 capa de espuma técnica súper suave de células abiertas
  - 1 capa de tejido anti-alérgico de color negro en contacto con la piel
- Disponible versión para fisonomía asiática

### 5 ELÁSTICO

- 1 línea de silicona antideslizante
- Doble hebilla para un ajuste rápido





13950-FBO € 53,00 + IVA/VAT  
**13953-FBO ASIAN FITTING FOAM**

CAT.0 DOUBLE



13950-FGA € 53,00 + IVA/VAT  
**13953-FGA ASIAN FITTING FOAM**

CAT.0 DOUBLE



13950-FGB € 53,00 + IVA/VAT  
**13953-FGB ASIAN FITTING FOAM**

CAT.0 DOUBLE



13950-FGN € 53,00 + IVA/VAT  
**13953-FGN ASIAN FITTING FOAM**

CAT.0 DOUBLE



13950-FNG € 53,00 + IVA/VAT  
**13953-FNG ASIAN FITTING FOAM**

CAT.0 DOUBLE



13950-FRB € 53,00 + IVA/VAT  
**13953-FRB ASIAN FITTING FOAM**

CAT.0 DOUBLE

FEATURES

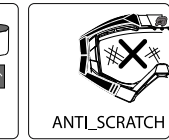
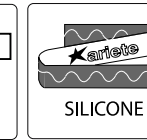
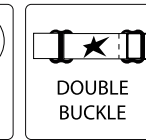
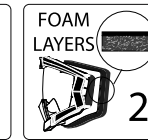
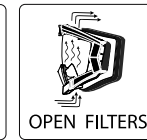
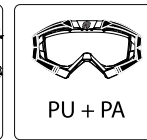
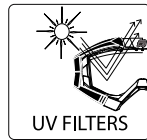
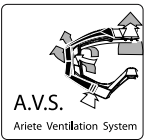

FEATURES



OPTIONAL

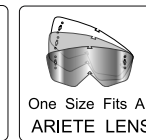
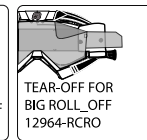
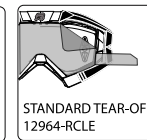
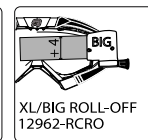

# GOGGLES RALLY



FEATURES	A.V.S. Ariete Ventilation System	O.T.G. Over The Glasses	UV FILTERS	ANTI_FOG	PU + PA	CLOSED FILTERS	FOAM LAYERS 3	DOUBLE BUCKLE	SILICONE	CARBON
	CD OUTRIGGERS		INCLUDED		MICROFIBRE BAG	OPTIONAL				
						One Size Fits All ARIETE LENS	XL/BIG ROLL-OFF 12962-RCRO	STANDARD TEAR-OFF 12964-MMLE		



14940-NDS

€ 90,00 + IVA/VAT

CAT. 3



SINGLE



FEATURES	A.V.S. Ariete Ventilation System	O.T.G. Over The Glasses	PU + PA	CLOSED FILTERS	ANTI_FOG	UV FILTERS	FOAM LAYERS 3	3D FOAM	QUICK RELEASE	SILICONE
	DOUBLE BUCKLE		INCLUDED		MICROFIBRE BAG	OPTIONAL				
						One Size Fits All ARIETE LENS	NOSE GUARD	XL/BIG ROLL-OFF 12962-RCRO	STANDARD TEAR-OFF 12964-MMLE	



13950-DNGS

€ 70,00 + IVA/VAT

CAT. 2



SINGLE

**SPECIAL FOR DESERT**

Alberto Ravardino



# SNOWMOBILE

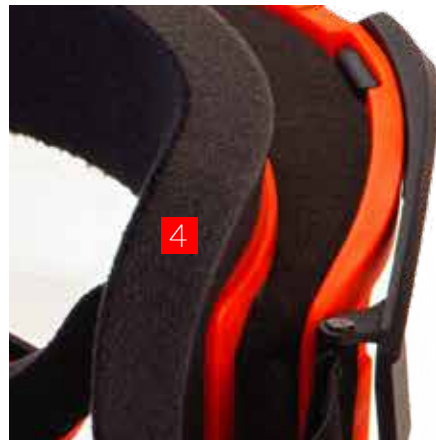

## IT

- 1 TELAI0**
  - Taglia media/grande
  - Impiego anche con occhiali correttivi (OTG)
  - Compatibile con il Kit BIG/XL Roll-Off
  - Materiale poliuretano flessibile anche a basse temperature
  - Colori anti UV
- 2 LENTE**
  - Lente doppia, cilindrica, ventilata
  - Nessuna distorsione ottica
  - Proprietà anti-appannamento
  - Protezione totale dai raggi UV
- 3 VENTILAZIONE**
  - A.V.S. Sistema di Ventilazione Ariete
  - Ventilazione migliorata
  - Filtri chiusi

- 4 SPUGNE**
  - Spugna con comfort eccezionale
  - Strato di pile ipoallergenico a contatto con la pelle
  - Spugna maggiorata
- 5 ELASTICO**
  - Elastico con silicone antiscivolo
  - Clip laterale per aggancio lenti a strappo
  - Doppia fibbia per regolazione

## FR

- 1 MONTURE**
  - Taille moyenne/grande
  - Compatible avec le port de lunettes de vue (O.T.G.)
  - Compatible avec le Kit BIG/XL Roll-Off
  - Matériau polyuréthane flexible même à basses températures
  - Coloris anti-UV
- 2 VERRE**
  - Verre double, cylindrique, ventilé
  - Verre anti distorsion optique
  - Meilleur traitement antibuée
  - Protection totale des rayons UV

- 3 VENTILATION**
  - A.V.S. Système de Ventilation Ariete
  - Ventilation accrue
  - Filtres fermés
- 4 MOUSSES**
  - Mousse pour un confort exceptionnel
  - Couche en polaire noire anti allergique en contact avec la peau
  - Mousse accrue
- 5 ELASTIQUE**
  - Elastique avec silicone antiglisse antiglisse
  - Clip latérale pour accrocher les verres lentilles amovibles
  - Double boucle de réglage

## UK

- 1 FRAME**
  - Medium/Large Fitment
  - O.T.G. (Over The Glasses) Design
  - Compatible with BIG/XL Roll-Off Kit
  - Tough PUR frame for low-temperature flexibility
  - Anti-UV lacquered frame
- 2 LENS**
  - Double, cylindrical, ventilated lens
  - Distortion-free lens
  - Anti-fog inner lens
  - UV rays total protection
- 3 VENT SYSTEM**
  - A.V.S. Ariete Ventilation System
  - Extra Ventilation
  - Closed filters
- 4 FOAM**
  - Sponge lining for unmatched comfort and feel
  - Hypo-allergenic foam in contact with the skin
  - Extra-thick foam
- 5 ELASTIC STRAP**
  - Elastic strap with anti-slip silicone
  - Pin to suit tear-off use
  - Double buckle

## ES

- 1 ESTRUCTURA**
  - Talla Medio / Grande
  - Uso con gafas correctivas (OTG)
  - Compatible con el Kit BIG/XL Roll-Off
  - Proyecto en poliuretano elástico y fuerte flexible a bajas temperaturas
  - Colores anti UV
- 2 LENTE**
  - Lente doble, cilíndrica, ventilada
  - Ninguna distorsión óptica
  - Mejor tratamiento anti-empañado
  - Protección total contra los rayos UV
- 3 VENTILACIÓN**
  - A.V.S. Sistema de Ventilación Ariete
  - Ventilación extra
  - Filtros cerrados
- 4 ESPUMA**
  - Espuma para una perfecta ergonomía
  - Capa de polar anti-alérgico en contacto con la piel
  - Espuma aumentada
- 5 ELÁSTICO**
  - Banda con silicona antideslizante
  - Con clip para instalación tirables
  - Doble hebilla para un ajuste rápido



14001-MB19 ADRENALINE € 54,00 + IVA/VAT

CAT.0 DOUBLE



14001-MBRA ADRENALINE € 54,00 + IVA/VAT

CAT.1 DOUBLE



14001-MNGG ADRENALINE € 54,00 + IVA/VAT

CAT.1 DOUBLE



13950-MBNA RC € 68,50 + IVA/VAT

CAT.1 DOUBLE



13950-MONC RC € 68,50 + IVA/VAT

CAT.0 DOUBLE



13950-MNOO RC € 68,50 + IVA/VAT

CAT.1 DOUBLE

COMMON FEATURES

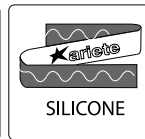
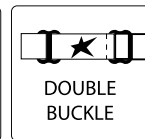
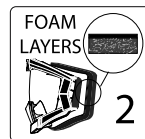
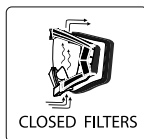
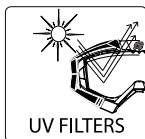
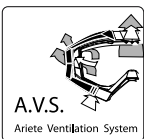

RC FEATURES

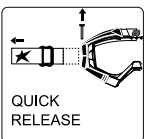
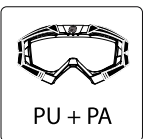

OPTIONAL

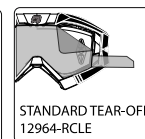
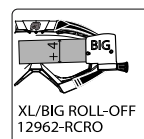



13950-MTNR RC

€ 89,<sup>70</sup> + IVA/VAT

CAT. 3 



DOUBLE



14940-MBAS MUDMAX

€ 89,<sup>70</sup> + IVA/VAT

CAT. 3 



DOUBLE



14940-MBRR MUDMAX

€ 89,<sup>70</sup> + IVA/VAT

CAT. 3 



DOUBLE

COMMON FEATURES

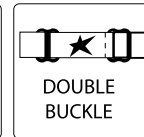
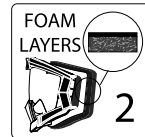
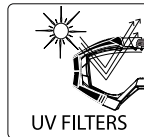
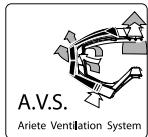

RC FEATURES

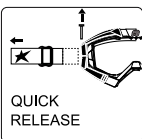
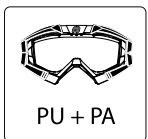

OPTIONAL

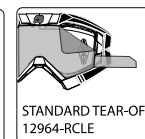
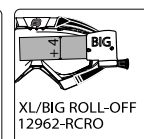
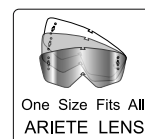



Gabriele Nannini - Photo F.Nannini



07 NEXT GEN

## IT

- 1 TELAIO**
  - Materiale poliuretano flessibile anche a basse temperature
  - Colori anti-UV
  - Taglia Small
  - Modello adatto ai caschi per bambini (KIDS)
- 2 LENTE**
  - Chiara in policarbonato
  - Miglior trattamento anti appannamento
  - Trattamento anti graffio
  - Nessuna distorsione ottica
  - Protezione totale dalle radiazioni UV
- 3 VENTILAZIONE**
  - A.V.S. Sistema di Ventilazione Ariete
  - Filtri aperti

- 4 SPUGNE**
  - Guarnizione a 2 strati composta da:
    - 1 strato di spugna tecnica super soft a cellule aperte
    - 1 strato di pile ipoallergenico nero a contatto con la pelle
- 5 ELASTICO**
  - Con silicone antiscivolo
  - Doppia fibbia di regolazione

## FR

- 1 MONTURE**
  - Monture en Polyuréthane flexible même à basses températures
  - Couleurs Anti-UV
  - Ce modèle convient aux casques enfants
- 2 VERRE**
  - Ecran clair polycarbonate
  - Traitement anti-rayure
  - Traitement antibuée haute performance
  - Sans distorsion optique
  - Protection totale des rayons UV
- 3 VENTILATION**
  - Système AVS (Ariete Ventilation System)
  - Ventilations équipées de filtres
- 4 MOUSSES**
  - Mousses double épaisseurs anti-allergique
- 5 ELASTIQUE**
  - Bandeau siliconé pour un maximum de grip
  - Double boucles de réglage

## UK

- 1 FRAME**
  - Tough PUR frame for low-temperature flexibility
  - Anti - UV colours
  - Small Fit
  - Suitable on helmets for children/Kids
- 2 LENS**
  - Clear lens in polycarbonate
  - Best anti-fog treatment
  - Anti-scratch treatment
  - No optical distortion
  - UV radiations total protection
- 3 VENT SYSTEM**
  - A.V.S. Ariete Ventilation System
  - Open filters
- 4 FOAM**
  - 2 foam layers composed of:
    - 1 super-soft technical foam layer with open cells
    - 1 hypo-allergenic foam layer in contact with the skin
- 5 ELASTIC STRAP**
  - Anti-slip silicone
  - Double buckle for quick adjustment

## ES

- 1 ESTRUCTURA**
  - Elaborada en poliuretano elástico fuerte y flexible a bajas temperaturas
  - Colores anti UV
  - Talla pequeña
  - Modelo adecuado para cascos de niño
- 2 LENTE**
  - Lente transparente en policarbonato
  - Mejor tratamiento anti-empañamiento
  - Tratamiento anti-rayado
  - Sin distorsión óptica
  - Protección total contra los rayos UV
- 3 VENTILACIÓN**
  - A.V.S. Sistema de Ventilación Ariete
  - Filtros abiertos
- 4 ESPUMA**
  - Interior de 2 capas compuesta de:
    - 1 capa de espuma técnica súper suave con células abiertas
    - 1 capa de tejido negro hipoalergénico en contacto con la piel
- 5 ELÁSTICO**
  - Silicona antideslizante
  - Doble hebilla para un ajuste rápido





12960-BNB

€ 35,70 + IVA/VAT

CAT.0 

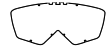

SINGLE



12960-NNB

€ 35,70 + IVA/VAT

CAT.0 



SINGLE



12960-NGNR

€ 35,70 + IVA/VAT

CAT.0 



SINGLE



12960-NGNA

€ 35,70 + IVA/VAT

CAT.0 



SINGLE



12960-NGNO

€ 35,70 + IVA/VAT

CAT.0 



SINGLE

FEATURES

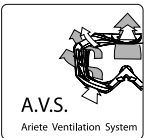

A.V.S.  
Ariete Ventilation System

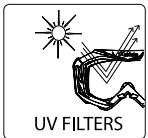

UV FILTERS



ANTI\_FOG



ANTI\_SCRATCH

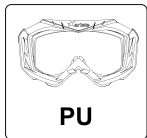

PU

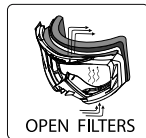

OPEN FILTERS

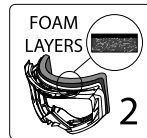

FOAM LAYERS  
2

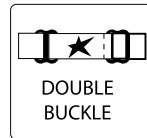

DOUBLE BUCKLE



SILICONE











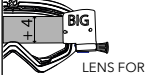
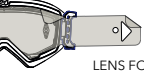
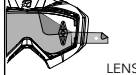

































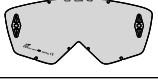





























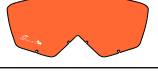













OPTIONAL



































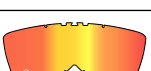



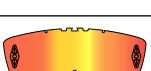



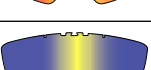



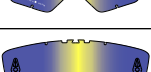









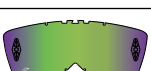













One Size Fits All  
ARIETE LENS

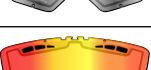





















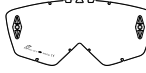



























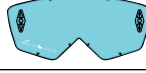



















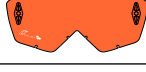



































		<b>GOGGLES ADRENALINE RC MUDMAX</b>	<b>XL/Big Roll-off</b>  LENS FOR XL/BIG ROLL-OFF	<b>Mudmax</b>  LENS FOR TEAR_OFF	<b>Adrenaline/RC</b>  LENS FOR TEAR_OFF											
<b>CAT. 0</b>		<b>CLEAR AIR 12961-RCFR</b> € 12, <sup>90</sup> + IVA/VAT		Suitable For Big/xl Roll-off <b>12962-RCRO</b>	Standard Tear-offs <b>12964-MMLE</b> Tear-offs For Roll-off <b>12964-RCRO</b>	Standard Tear-offs <b>12964-RCLE</b> Tear-offs For Roll-off <b>12964-RCRO</b>										
		<b>CLEAR AIR 12961-RCCH</b> € 14, <sup>00</sup> + IVA/VAT		Suitable For Big/xl Roll-off <b>12962-RCRO</b>	Standard Tear-offs <b>12964-MMLE</b> Tear-offs For Roll-off <b>12964-RCRO</b>	Standard Tear-offs <b>12964-RCLE</b> Tear-offs For Roll-off <b>12964-RCRO</b>										
		<b>CLEAR AIR 12961-SCCH</b> € 11, <sup>90</sup> + IVA/VAT														
		<b>CLEAR AIR 12961-DCV</b> € 20, <sup>25</sup> + IVA/VAT														
		<b>PLUS 12961-RCPL</b> € 21, <sup>50</sup> + IVA/VAT		Suitable For Big/xl Roll-off <b>12962-RCRO</b>	Standard Tear-offs <b>12964-MMLE</b> Tear-offs For Roll-off <b>12964-RCRO</b>	Standard Tear-offs <b>12964-RCLE</b> Tear-offs For Roll-off <b>12964-RCRO</b>										
		<b>PLUS 12961-SCPL</b> € 19, <sup>50</sup> + IVA/VAT														
<b>CAT. 1</b>		<b>YELLOW DESERT 12961-RCG</b> € 14, <sup>50</sup> + IVA/VAT		Suitable For Big/xl Roll-off <b>12962-RCRO</b>	Standard Tear-offs <b>12964-MMLE</b> Tear-offs For Roll-off <b>12964-RCRO</b>	Standard Tear-offs <b>12964-RCLE</b> Tear-offs For Roll-off <b>12964-RCRO</b>										
		<b>YELLOW DESERT 12961-DCGV</b> € 20, <sup>25</sup> + IVA/VAT														
		<b>LIGHT CORAL 12961-RCAR</b> € 14, <sup>50</sup> + IVA/VAT		Suitable For Big/xl Roll-off <b>12962-RCRO</b>	Standard Tear-offs <b>12964-MMLE</b> Tear-offs For Roll-off <b>12964-RCRO</b>	Standard Tear-offs <b>12964-RCLE</b> Tear-offs For Roll-off <b>12964-RCRO</b>										
		<b>LIGHT CORAL 12961-SCAR</b> € 13, <sup>30</sup> + IVA/VAT														
		<b>LIGHT CORAL 12961-DCOV</b> € 20, <sup>25</sup> + IVA/VAT														
		<b>BLUE CREEK 12961-RCFA</b> € 14, <sup>50</sup> + IVA/VAT		Suitable For Big/xl Roll-off <b>12962-RCRO</b>	Standard Tear-offs <b>12964-MMLE</b> Tear-offs For Roll-off <b>12964-RCRO</b>	Standard Tear-offs <b>12964-RCLE</b> Tear-offs For Roll-off <b>12964-RCRO</b>										
		<b>BLUE CREEK 12961-SCFA</b> € 13, <sup>30</sup> + IVA/VAT														

GOGGLES ADRENALINE RC MUDMAX		XL/Big Roll-off	Mudmax	Adrenaline/RC											
		LENS FOR XL/BIG ROLL_OFF	LENS FOR TEAR_OFF	LENS FOR TEAR_OFF	SINGLE	DOUBLE	100% UV FILTERS	NO FOG	ANTI_SCRATCH	VENTILATED	MULTILAYERS TREATMENT	MIRRORED	EUROPEAN CONFORMITY		
CAT. 2 	BLUE CREEK 12961-DCFA € 20, <sup>25</sup> + IVA/VAT														
	SILVER CHROME 12961-RCSP € 25, <sup>50</sup> + IVA/VAT		Suitable For Big/xl Roll-off <b>12962-RCRO</b>	Standard Tear-offs <b>12964-MMLE</b> Tear-offs For Roll-off <b>12964-RCRO</b>	Standard Tear-offs <b>12964-RCLE</b> Tear-offs For Roll-off <b>12964-RCRO</b>										
	SILVER CHROME 12961-SCSC € 27, <sup>00</sup> + IVA/VAT														
	SILVER CHROME 12961-DCSV € 30, <sup>75</sup> + IVA/VAT														
	MULTI LAYER RED 12961-MLR € 27, <sup>00</sup> + IVA/VAT														
	MULTI LAYER RED 12961-RMRC € 31, <sup>50</sup> + IVA/VAT		Suitable For Big/xl Roll-off <b>12962-RCRO</b>	Standard Tear-offs <b>12964-MMLE</b> Tear-offs For Roll-off <b>12964-RCRO</b>	Standard Tear-offs <b>12964-RCLE</b> Tear-offs For Roll-off <b>12964-RCRO</b>										
	MULTI LAYER BLUE 12961-MLA € 27, <sup>00</sup> + IVA/VAT														
	MULTI LAYER BLUE 12961-RMAC € 31, <sup>50</sup> + IVA/VAT		Suitable For Big/xl Roll-off <b>12962-RCRO</b>	Standard Tear-offs <b>12964-MMLE</b> Tear-offs For Roll-off <b>12964-RCRO</b>	Standard Tear-offs <b>12964-RCLE</b> Tear-offs For Roll-off <b>12964-RCRO</b>										
CAT. 3 	MULTI LAYER GREEN 12961-MLV € 27, <sup>00</sup> + IVA/VAT														
	MULTI LAYER GREEN 12961-RMVC € 31, <sup>50</sup> + IVA/VAT		Suitable For Big/xl Roll-off <b>12962-RCRO</b>	Standard Tear-offs <b>12964-MMLE</b> Tear-offs For Roll-off <b>12964-RCRO</b>	Standard Tear-offs <b>12964-RCLE</b> Tear-offs For Roll-off <b>12964-RCRO</b>										
	SILVER CHROME 12961-SCST € 27, <sup>00</sup> + IVA/VAT														
	SILVER CHROME 12961-DCST € 34, <sup>95</sup> + IVA/VAT														
MULTI LAYER 12961-DMLR € 39, <sup>95</sup> + IVA/VAT															































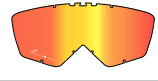





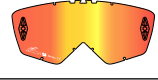





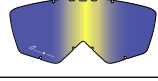





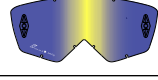



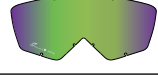



GOGGLES <b>07 NEXTGEN</b> only NO XL/BIG ROLL-OFF														
			LENS FOR TEAR_OFF	SINGLE	DOUBLE	100% UV FILTERS	NO FOG	ANTI_SCRATCH	VENTILATED	One Size Fits All ARIETE FRAMES	MULTILAYERS TREATMENT	MIRRORED	EUROPEAN CONFORMITY	
CAT. 0		<b>CLEAR AIR</b> 12961-PCCH € 12, <sup>65</sup> + IVA/VAT		STANDARD TEAR-OFFS <b>12964 TOLE</b>										
		<b>CLEAR AIR</b> 12961-SCCH € 11, <sup>90</sup> + IVA/VAT												
		<b>CLEAR AIR</b> 12961-DCV € 20, <sup>25</sup> + IVA/VAT												
CAT. 1		<b>MULTI LAYER RAINBOW</b> 12961-MUAZ € 32, <sup>35</sup> + IVA/VAT		STANDARD TEAR-OFFS <b>12964 TOLE</b>										
		<b>BLUE SKY</b> 12961-PCAZ € 13, <sup>25</sup> + IVA/VAT		STANDARD TEAR-OFFS <b>12964 TOLE</b>										
		<b>YELLOW DESERT</b> 12961-PCG € 13, <sup>25</sup> + IVA/VAT		STANDARD TEAR-OFFS <b>12964 TOLE</b>										
		<b>YELLOW DESERT</b> 12961-DCGV € 20, <sup>25</sup> + IVA/VAT												
		<b>LIGHT CORAL</b> 12961-PCAR € 13, <sup>25</sup> + IVA/VAT		STANDARD TEAR-OFFS <b>12964 TOLE</b>										
		<b>LIGHT CORAL</b> 12961-SCAR € 13, <sup>30</sup> + IVA/VAT												
		<b>LIGHT CORAL</b> 12961-DCOV € 20, <sup>25</sup> + IVA/VAT												
		<b>BLUE CREEK</b> 12961-PCFA € 13, <sup>25</sup> + IVA/VAT		STANDARD TEAR-OFFS <b>12964 TOLE</b>										
		<b>BLUE CREEK</b> 12961-SCFA € 13, <sup>30</sup> + IVA/VAT												
	<b>BLUE CREEK</b> 12961-DCFA € 20, <sup>25</sup> + IVA/VAT													





















**GOGGLES**  
**07 NEXTGEN** only  
**NO XL/BIG ROLL-OFF**

 LENS FOR TEAR_OFF	 SINGLE	 DOUBLE	 100% UV FILTERS	 NO FOG	 ANTI_SCRATCH	 VENTILATED	 One Size Fits All ARIETE FRAMES	 MULTILAYERS TREATMENT	 MIRRORED	 EUROPEAN CONFORMITY
---	---	---	--	--	--	--	--	--	---	--

CAT. 2 

SILVER CHROME 12961-PCSP € 27, <sup>00</sup> + IVA/VAT		STANDARD TEAR-OFFS 12964 TOLE										
SILVER CHROME 12961-SCSC € 27, <sup>00</sup> + IVA/VAT												
SILVER CHROME 12961-DCSV € 30, <sup>75</sup> + IVA/VAT												
MULTI LAYER RED 12961-MLR € 27, <sup>00</sup> + IVA/VAT												
MULTI LAYER RED 12961-MLRC € 27, <sup>00</sup> + IVA/VAT		STANDARD TEAR-OFFS 12964 TOLE										
MULTI LAYER BLUE 12961-MLA € 27, <sup>00</sup> + IVA/VAT												
MULTI LAYER BLUE 12961-MLAC € 27, <sup>00</sup> + IVA/VAT		STANDARD TEAR-OFFS 12964 TOLE										
MULTI LAYER GREEN 12961-MLV € 27, <sup>00</sup> + IVA/VAT												
MULTI LAYER GREEN 12961-MLVC € 27, <sup>00</sup> + IVA/VAT		STANDARD TEAR-OFFS 12964 TOLE										

CAT. 3 

SILVER CHROME 12961-SCST € 27, <sup>00</sup> + IVA/VAT												
SILVER CHROME 12961-DCST € 34, <sup>95</sup> + IVA/VAT												
MULTI LAYER 12961-DMLR € 39, <sup>95</sup> + IVA/VAT												

**STANDARD TEAR-OFFS**  
**12964-TOLE** € 23,<sup>20</sup> + IVA/VAT  
 Suitable for:  
**07-ADRENALINE-RC**

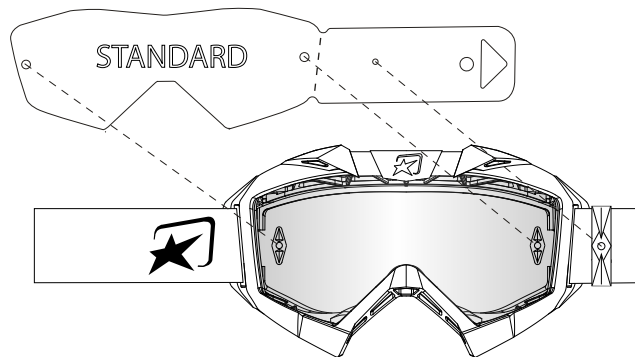

IT Kit 5 pacchetti, 6 Tear-offs/pacchetto. Lenti a strappo standard da applicare sulla lente.

UK Kit 5 stacks, 6 Tear-offs/stack Standard tear-offs to place on the lenses.

FR Kit 5 paquets, 6 tear-offs/ paquet. Verres lentilles amovibles standard à appliquer sur le masque.

ES Kit 5 paquetes, 6 Tear-offs/paquete. Tirables estandard para utilizar sobre la lente.

**RELATED LENSES**

- 12961-PCCH
- 12961-PCG
- 12961-PCAR
- 12961-PCFA
- 12961-PCAZ
- 12961-PCSP
- 12961-MUAZ
- 12961-MLAC
- 12961-MLRC
- 12961-MLVC

COMPATIBLE



**STANDARD TEAR-OFFS**  
**12964-RCLE** € 23,<sup>20</sup> + IVA/VAT  
 Suitable for:  
**ADRENALINE-RC**

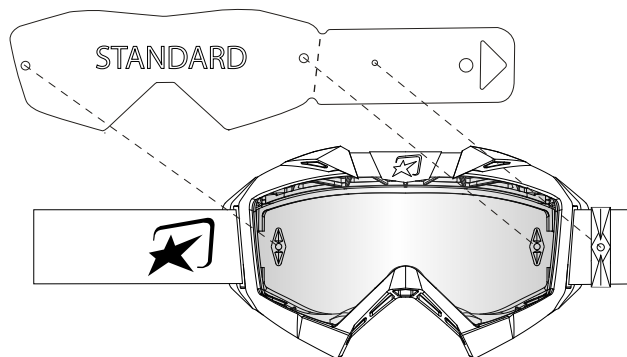

IT Kit 5 pacchetti, 6 Tear-offs/pacchetto. Lenti a strappo standard da applicare sulla lente.

UK Kit 5 stacks, 6 Tear-offs/stack Standard tear-offs to place on the lenses.

FR Kit 5 paquets, 6 tear-offs/ paquet. Verres lentilles amovibles standard à appliquer sur le masque.

ES Kit 5 paquetes, 6 Tear-offs/paquete. Tirables estandard para utilizar sobre la lente.

**RELATED LENSES**

- 12961-RCCH
- 12961-RCG
- 12961-RCAR
- 12961-RCFA
- 12961-RCSP
- 12961-RMAC
- 12961-RMRC
- 12961-RMVC
- 12961-RCPL

OPTIMIZED



**STANDARD TEAR-OFFS**  
**12964-MMLE** € 23,<sup>20</sup> + IVA/VAT  
 Suitable for:  
**MUDMAX**

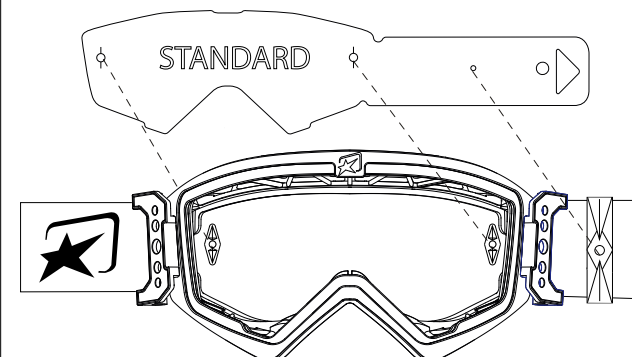

IT Kit 5 pacchetti, 6 Tear-offs/pacchetto. Lenti a strappo standard da applicare sulla lente.

UK Kit 5 stacks, 6 Tear-offs/stack Standard tear-offs to place on the lenses.

FR Kit 5 paquets, 6 tear-offs/ paquet. Verres lentilles amovibles standard à appliquer sur le masque.

ES Kit 5 paquetes, 6 Tear-offs/paquete. Tirables estandard para utilizar sobre la lente.

**RELATED LENSES**

- 12961-RCCH
- 12961-RCG
- 12961-RCAR
- 12961-RCFA
- 12961-RCSP
- 12961-RMAC
- 12961-RMRC
- 12961-RMVC
- 12961-RCPL

OPTIMIZED



## TEAR-OFF FOR XL/BIG ROLL\_OFF

12964-RCRO € 13,95 + IVA/VAT

Suitable for:

**ADRENALINE-RC-MUDMAX**

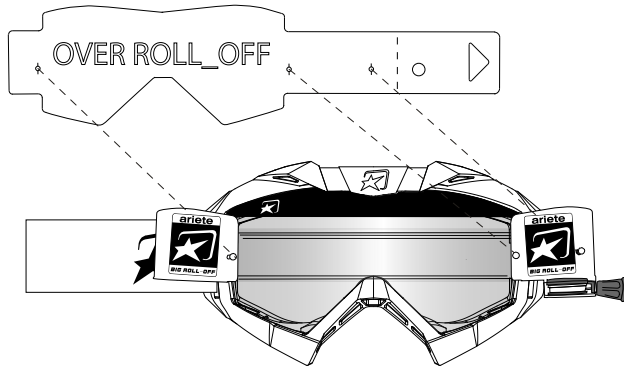

IT Kit 3 pacchetti, 6 Tear-offs/pacchetto. Lenti a strappo specifiche da applicare sul Roll-off.

UK Kit 3 stacks, 6 Tear-offs/stack. Specific tear-offs to place on the Roll-off system.

FR Kit 3 paquets, 6 tear-offs/ paquet. Verres lentilles amovibles standard à appliquer sur Roll-off.

ES Kit 3 paquetes, 6 Tear-offs/paquete. Tirables específicos para aplicar sobre el Roll-off.

### RELATED LENSES

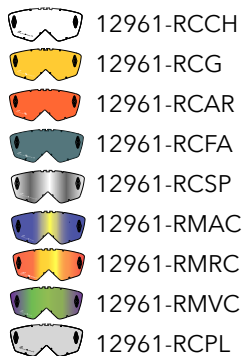

OPTIMIZED



## TEAR-OFF RACING PINS

12964-RE € 3,50 + IVA/VAT 2pcs

**07 - ADRENALINE - RC - MUDMAX**

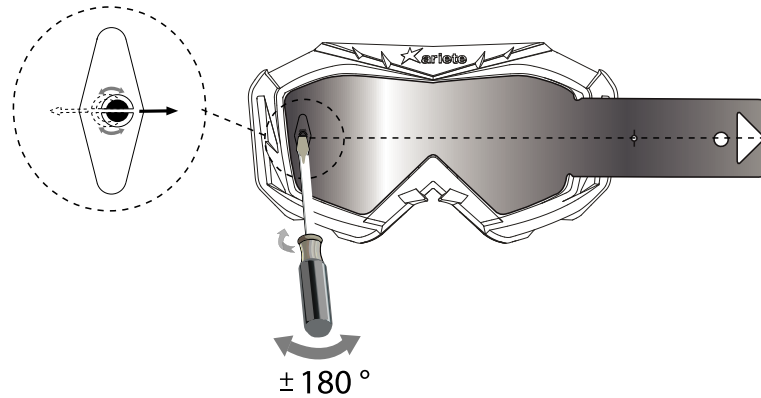

IT Clips eccentriche regolabili per tear-offs. Tendono al massimo la lente a strappo evitando che polvere e sporco si infilino tra il tear-off e la lente, vendute a paio;uso professionale.

UK Eccentric pins for precise tear-off adjustment to avoid dust between lens and tearoff, sold in pairs, professional use.

FR Clips/attaches excentriques ajustables pour tear-offs. Elles étendent au maximum les verres lentilles amovibles pour éviter l'infiltration de poussières et salissures entre le tear-off et l'écran, vendues par paire; à usage professionnel.

ES Clips regulables para tender al máximo el tear-off evitando que el polvo y la suciedad se introduzcan entre la lente removible y el cristal, se venden por pares, uso profesional.

### RELATED LENSES

Tutte le lenti Ariete  
All the lenses Ariete  
Tous les verres Ariete  
Todas las lentes Ariete

OPTIMIZED





# APPLICATIONS

 07 NEXT GEN  ADRENALINE  RC  MUDMAX



## KIT BIG/XL ROLL-OFF

- IT 2 canistri / 2 rullini / 1 guida di scorrimento/ 1 mud flap  
UK 2 canisters / 2 rolls of film / 1 anti-stick slide rail / 1 mud flap  
FR 2 canisters / 2 rouleaux de pellicule transparente / 1 grille anti adhésion / 1 deflecteur  
ES 2 contenedores / 2 rollos de película transparente / 1 carril transparentes / 1 mud flap

12962-RCRO **RC/ADRENALINE/MUDMAX** € 52,<sup>55</sup> + IVA/VAT



## ASSEMBLED LENS BIG/XL ROLL-OFF

- IT 1 lente 12961-RCFR per BIG/XL Roll-Off / 2 canistri premontati / 2 rullini /  
1 guida di scorrimento / 1 mud flap / 6 Tear-offs for Roll-Off gratis  
UK 1 lens 12961-RCFR for BIG/XL Roll-Off / 2 assembled canisters / 2 rolls of  
film / 1 anti-stick slide rail / 1 mud flap / 6 Tear-offs for Roll-Off for free  
FR 1 verre lentille 12961-RCFR pour XL/BIG Roll-Off / 2 canisters  
préassemblés/ 2 rouleaux de pellicule transparente /1 grille anti adhésion /  
1 deflecteur / 6 Tear-offs pour Roll-Off gratuits  
ES 1 lente 12961-RCFR para BIG/XL Roll-Off / 2 contenedores puestos / 2  
rollos de película transparente / 1 carril transparentes / 1 mud flap /6  
Tear-offs for Roll-Off sin cargo

12961-RCRO **RC/ADRENALINE/MUDMAX** € 65,<sup>10</sup> + IVA/VAT



MUD FLAPS

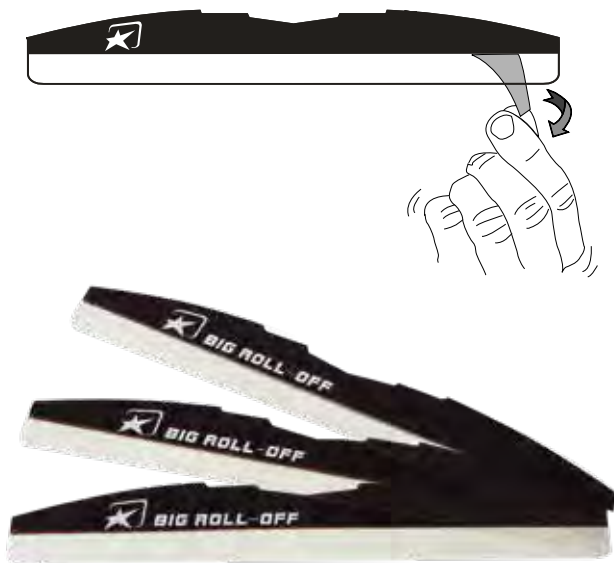

12963-RCMF 3 pcs. **RC/ADRENALINE** € 10,<sup>30</sup> + IVA/VAT  
 12963-MMMF 3 pcs. **MUDMAX** € 10,<sup>30</sup> + IVA/VAT

SLIDING RAILS

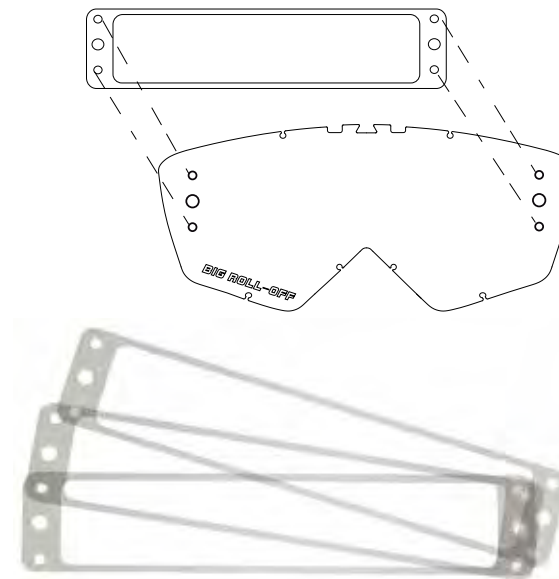

12967-RC 3 pcs. **RC/ADRENALINE/MUDMAX** € 5,<sup>30</sup> + IVA/VAT

BIG/XL ROLL-OFF FILMS

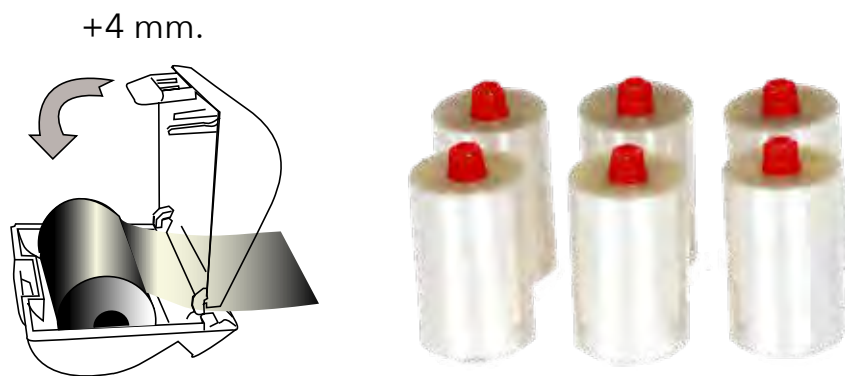

12962-RCRU 6 pcs. **RC/ADRENALINE/MUDMAX** € 27,<sup>90</sup> + IVA/VAT

BIG/XL ROLL-OFF LENS

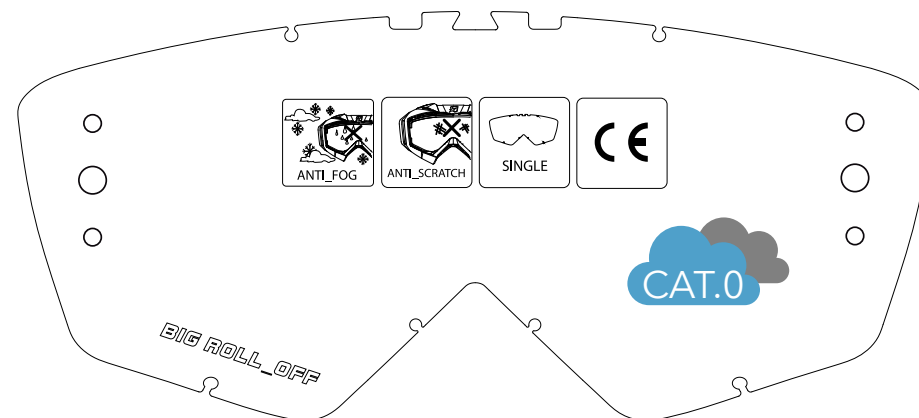

12961-RCFR **RC/ADRENALINE/MUDMAX** € 12,<sup>90</sup> + IVA/VAT



14001-RO € 96,<sup>90</sup> + IVA/VAT  
BIG/XL ROLL-OFF **ADRENALINE** GOGGLES



14940-BRO € 110,<sup>00</sup> + IVA/VAT  
BIG/XL ROLL-OFF **MUDMAX** GOGGLES



13950-RO € 104,<sup>00</sup> + IVA/VAT  
13953-RO € 104,<sup>00</sup> + IVA/VAT  
BIG/XL ROLL-OFF **RC** GOGGLES



14940-NRO € 110,<sup>00</sup> + IVA/VAT  
BIG/XL ROLL-OFF **MUDMAX** GOGGLES



13951-ATL € 12,<sup>60</sup> + IVA/VAT

IT Paio ricambio chele per fissaggio elastico, un paio di perni incluso  
 UK Spare QD outriggers for head-band attachment, pair of pins included  
 FR Paire de pins de rechange pour fixation bandeau élastique, 1 paire tiges incluse  
 ES Juego recambio garras para la tracción del elástico, un juego de enganches incluido



FLUO COLOR

13951-GLF  
 € 12,<sup>60</sup> + IVA/VAT



FLUO COLOR

13951-OLF  
 € 12,<sup>60</sup> + IVA/VAT



13951-R  
 € 6,<sup>30</sup> + IVA/VAT



13951-N  
 € 6,<sup>30</sup> + IVA/VAT



13951-B  
 € 6,<sup>30</sup> + IVA/VAT



13951-A  
 € 6,<sup>30</sup> + IVA/VAT



13951-GR  
 € 6,<sup>30</sup> + IVA/VAT



13952 € 6,<sup>30</sup> + IVA/VAT

IT Ricambio 4 perni per elastico  
 UK 4 spare pins for QD outriggers  
 FR 4 tiges de rechange pour pins externes  
 ES 4 enganches de recambio para garras



12966-RC € 7,<sup>00</sup> + IVA/VAT

IT Paranaso  
 UK Noseguard  
 FR Protège nez  
 ES Cubrenariz



- IT Custodia in microfibra con tasca interna per una lente di ricambio
- UK Microfibre bag with internal pocket for a spare lens
- FR Housse en microfibre avec poche interne pour verre de rechange
- ES Bolsa de microfibra con bolsillo interno para una lente de repuesto

12965-B

€ 5,<sup>50</sup> + IVA/VAT



#### RACING GOGGLES CASE

- IT - 1 tasca ampia per tear-offs con chiusura zip
- 1 tasca aperta per le lenti
- 3 tasche di dimensioni varie
- 4 divisori interni rimovibili fissati con velcro
- UK - 1 large pocket with zip closure for tear-offs
- 1 open pocket for lenses
- 3 pockets in varied sizes
- 4 removable internal dividers with Velcro
- FR - 1 large poche avec fermeture éclair pour les tear-offs
- 1 poche ouverte pour les verres
- 3 poches internes, différents formats
- 4 séparateurs amovibles avec Velcro
- ES - 1 bolsillo amplio con cremallera para tear-offs
- 1 bolsillo abierto para lentes
- 3 bolsillos interiores, distintos formatos
- 4 divisorios removibles con velcro

12965/A

€ 36,<sup>90</sup> + IVA/VAT

RK HOOB

# MUDMAX RACER

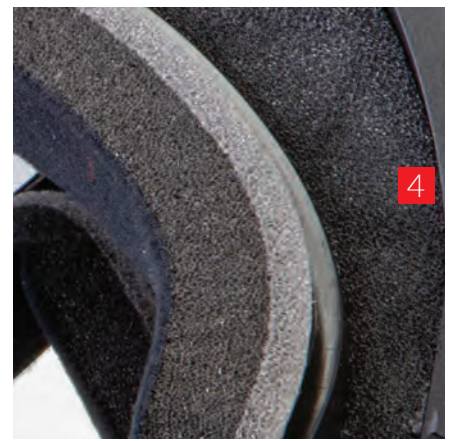

## IT

### 1 TELAIO

- Taglia Media
- Campo di visione ampliato sul bordo inferiore, ottimizzato per le discese
- Impiego anche con occhiali correttivi (O.T.G.)
- Materiale poliuretano flessibile anche a basse temperature
- Colori anti-UV
- Compatibile con il Kit BIG/XL Roll-Off 12962-RCRO
- Certificata CE

### 2 LENTE

- Lente "Plus" fumé specchiata cat. 1 cod.12961-SCPL
- Nessuna distorsione ottica
- Miglior trattamento anti-appannamento
- Protezione totale dai raggi UV

### 3 VENTILAZIONE

- A.V.S. Sistema di Ventilazione Ariete
- Ventilazione maggiorata
- Filtri aperti

### 4 SPUGNE

- Guarnizione a 3 strati composta da:
  - 1 strato di spugna tecnica super soft a cellule aperte
  - 1 strato di spugna a media densità
  - 1 strato di pile ipoallergenico a contatto con la pelle

### 5 ELASTICO

- Elastico h. 30 mm con silicone antiscivolo
- Doppia fibbia per una veloce regolazione

### ACCESSORI INCLUSI

Custodia in microfibra con tasca interna per una lente di ricambio

## FR

### 1 MONTURE

- Taille Moyenne
- Champ de vision agrandi sur le bord inférieur, optimisé pour les pentes
- Compatible avec le port de lunettes de vue (O.T.G.)
- Matériau polyuréthane flexible même à basses températures
- Coloris anti-UV
- Compatible avec le Kit Roll-Off version BIG/XL 12962-RCRO
- Certifiée CE

### 2 VERRE

- Verre "Plus" fumé effet miroir cat. 1 cod.12961-SCPL
- Verre anti distorsion optique
- Meilleur traitement antibuée
- Protection totale des rayons UV

### 3 VENTILATION

- A.V.S. Système de Ventilation Ariete
- Ventilation accrue
- Filtres ouverts

### 4 MOUSSES

- Contour à triple épaisseur composé par:
  - 1 couche de mousse technique ultra douce à cellules ouvertes
  - 1 couche de mousse à densité moyenne
  - 1 couche en polaire noire anti allergique en contact avec la peau

### 5 ELASTIQUE

- Elastique h. 30 mm avec silicone antiglisse
- Double boucle pour un réglage rapide

### ACCESSOIRES INCLUS

Housse en microfibre avec poche interne pour verre de rechange

## UK

### 1 FRAME

- Medium Fit
- Enhanced vision field on the lower lens for downhill riding
- Comfortably Fits Glasses (O.T.G.)
- Tough PUR frame for low-temperature flexibility
- Anti-UV colours
- Compatible with BIG/XL Roll-Off Kit 12962-RCRO
- CE approved

### 2 LENS

- Mirrored smoked lens "Plus" cat. 1 cod.12961-SCPL
- Best anti-fog treatment
- No optical distortion
- UV radiations total protection

### 3 VENT SYSTEM

- A.V.S. Ariete Ventilation System
- Extra Ventilation
- Open filters

### 4 FOAM

- Three-layer face foam specification composed of:
  - 1 super-soft technical foam layer with open cells
  - 1 medium density foam layer
  - 1 hypo-allergenic foam layer in contact with the skin

### 5 ELASTIC STRAP

- 30 mm height elastic strap with 1 anti-slip silicone
- Double buckle for quick adjustment

### INCLUDED ACCESSORIES

Microfibre bag with internal pocket for a spare lens

## ES

### 1 ESTRUCTURA

- Talla Media
- Campo de visión aumentado en el borde inferior especialmente indicado para la conducción en descenso
- Posibilidad de uso con gafas graduadas (OTG)
- Elaborada en poliuretano elástico fuerte y flexible a bajas temperaturas
- Colores anti UV
- Compatible con el Kit BIG/XL Roll-Off 12962-RCRO
- Certificación CE

### 2 LENTE

- Lente de espejo ahumada "Plus" cat. 1 cod.12961-SCPL
- Sin distorsión óptica
- Mejor tratamiento anti-empañamiento
- Protección total contra los rayos UV

### 3 VENTILACIÓN

- A.V.S. Sistema de Ventilación Ariete
- Ventilación extra
- Filtros abiertos

### 4 ESPUMA

- Especificación facial de tres capas compuesta de:
  - 1 capa de espuma técnica súper suave con células abiertas
  - 1 capa de espuma de densidad media
  - 1 capa de tejido hipoalergénico en contacto con la piel

### 5 ELÁSTICO

- Banda de 30 mm de altura con silicona antideslizante
- Doble hebilla para un ajuste rápido

### ACCESORIOS INCLUIDOS

Bolsa de microfibra con bolsillo interno para una lente de repuesto





14940-NGR € 60,00 + IVA/VAT  
 CAT. 1 SINGLE



14940-BRA € 60,00 + IVA/VAT  
 CAT. 1 SINGLE



14940-CMV € 60,00 + IVA/VAT  
 CAT. 1 SINGLE



14940-NBC € 60,00 + IVA/VAT  
 CAT. 1 SINGLE



14940-VVC € 60,00 + IVA/VAT  
 CAT. 1 SINGLE



14940-BBG € 60,00 + IVA/VAT  
 CAT. 1 SINGLE

FEATURES

A.V.S. Ariete Ventilation System	O.T.G. Over The Glasses	UV FILTERS	ANTI_FOG	PU	OPEN FILTERS	FOAM LAYERS 3	DOUBLE BUCKLE	SILICONE	CE
-------------------------------------	----------------------------	------------	----------	----	--------------	------------------	---------------	----------	----

INCLUDED

MICROFIBRE BAG
----------------

OPTIONAL

QD OUTRIGGERS	One Size Fits All ARIETE LENS	LENS FOR XL/BIG ROLL_OFF	LENS FOR TEAR_OFF 12964-MMLE
---------------	-------------------------------	--------------------------	------------------------------





14940-MVV

€ 72,00 + IVA/VAT

CAT. 2 



SINGLE



14940-MAA

€ 72,00 + IVA/VAT

CAT. 2 



SINGLE



14940-MSA

€ 72,00 + IVA/VAT

CAT. 2 



SINGLE



14940-MRS

€ 72,00 + IVA/VAT

CAT. 2 



SINGLE



Lucia Vazquez - Photo: 5special

GOGGLES MUDMAX RACER - SPECIAL | 2020





Photo RK HOOB



FEATHER

## IT

### 1 TELAIO

- Telaio sottile in stile "minimal"
- Telaio di medie proporzioni
- Telaio ultra leggero (67 grammi)

### 2 LENTE

- Lente fotocromatica cat.0->1
- Sferica
- Lavorata a macchina
- Lente ventilata
- Lente specchiata
- Pu+ film sensibile all'intensita' luminosa
- Lente anti-distorsione
- Protezione totale dai raggi uv

### 3 VENTILAZIONE

- A.V.S. Sistema di Ventilazione Ariete
- Filtri aperti

### 4 BANDA ELASTICA

- Altezza 30 mm in stile vintage
- Striscia siliconica anti scivolo
- Sistema doppia fibbia per un rapido aggiustamento della lunghezza dell'elastico

### 5 3 STRATI DI SPUGNA

- Spugne termoformate per un impareggiabile comfort e calzata al viso
- Primo strato di spugna con tecnologia a celle chiuse
- Secondo strato di spugna super morbida con tecnologia a celle aperte
- Terzo strato in pile ipo-allergenico a contatto con la pelle

### ACCESSORI INCLUSI

Custodia in microfibra

## FR

### 1 MONTURE

- Monture mince en style "minimaliste"
- Monture aux proportions moyennes
- Monture ultra legere (67 grammes)

### 2 VERRE

- Verre photochromique cat. 0->1
- Spherique
- Usiné
- Verre ventilé
- Verre miroité
- Pu+ film sensible à l'intensité lumineuse
- Verre anti-distorsion
- Protection totale des rayons uv

### 3 VENTILATION

- A.V.S. Systeme de Ventilation Ariete
- Filtres ouverts

### 4 BANDE ELASTIQUE

- Hauteur 30 mm en style vintage
- Bande en silicone anti-glisse
- Systeme de double boucle pour un réglage rapide de la longueur de l'elastique

### 5 3 COUCHES DE MOUSSE

- Mousses thermoformees pour un confort et une vestibilité sur le visage sans egales
- Premiere couche de mousse avec technologie à cellules fermees
- Deuxieme couche de mousse super douce avec technologie à cellules fermees
- Troisieme couche en polaire hypoallegenique en contact avec la peau

### ACCESSOIRES INCLUS

Housse en microfibre

## UK

### 1 FRAME

- Frameless goggles
- Medium Fitment
- Ultra Lightweight (67 grams)

### 2 LENS

- Photochromic cat.0->1
- Spherical
- Machined
- Ventilated lens
- Mirrored lens
- PU + Light-sensitive film
- Distortion-free lens
- UV rays total protection

### 3 VENT SYSTEM

- A.V.S. Ariete Ventilation System
- Open filters

### 4 ELASTIC STRAP

- 30 mm Height
- Anti-slip silicone bead
- Double buckle for quick adjustment

### 5 3-LAYER FACE FOAM

- 1st technical foam layer with closed cells
- 2nd super-soft technical foam layer with open cells
- 3rd hypo-allergenic pile layer in contact with the skin
- 3D Thermo-formed sponge lining for unmatched comfort and feel

### INCLUDED ACCESSORIES

Microfibre bag

## ES

### 1 MONTURA

- Montura fina estilo "minimal"
- Montura de proporciones medianas
- Montura ultra ligera (67 gramos)

### 2 LENTE

- Lente fotocromática cat.0->1
- Esférica
- Elaborada a máquina
- Lente ventilada
- Lente de espejo
- Pu+ película sensible a la intensidad luminosa
- Lente anti-distorsión
- Protección total contra los rayos uv

### 3 VENTILACIÓN

- A.V.S. Sistema de Ventilación Ariete
- Filtros abiertos

### 4 BANDA ELÁSTICA

- Anchura 30 mm estilo vintage
- Banda antideslizante de silicona
- Sistema doble hebilla para ajustar rápidamente la longitud del elástico

### 5 3 CAPAS DE ESPUMA

- Espumas termoformadas para un confort inigualable y perfecta adaptacion al rostro
- Primera capa de espuma con tecnología de celdas cerradas
- Segunda capa de espuma súper suave con tecnología de celdas abiertas
- Tercera capa de tejido hipoalergénico al contacto con la piel

### ACCESORIOS INCLUIDOS

Bolsa de microfibra



14920-BNBG € 110,00 + IVA/VAT

CAT. 0 - 1 SINGLE



14920-MVC € 110,00 + IVA/VAT

CAT. 0 - 1 SINGLE



14920-TNB € 110,00 + IVA/VAT

CAT. 0 - 1 SINGLE



14920-TCCR € 110,00 + IVA/VAT

CAT. 0 - 1 SINGLE



14920-TNGR € 110,00 + IVA/VAT

CAT. 0 - 1 SINGLE



14920-MMV € 110,00 + IVA/VAT

CAT. 0 - 1 SINGLE

FEATURES



PA + PC



UV FILTERS



MACHINED



FULL VIEW

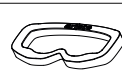

3D FOAM



FOAM LAYERS

3



ULTRA LIGHT



DOUBLE BUCKLE



SILICONE



UV

UV

LIGHT SENSITIVE

FEATURES



MIRRORED



PHOTOCHROMIC  
CAT. 0-1



VENTILATED LENS



CE

INCLUDED

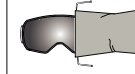

MICROFIBER  
BAG





Ivan Fiori - Photo @scrambike



ARIETE GOGGLES | 2020

@doyparkkk



FEATHER LITE



## IT

### 1 TELAIO

- Telaio sottile in stile "minimal"
- Telaio di medie proporzioni
- Telaio ultra leggero (67 grammi)

### 2 LENTE

- Lente cat.2
- Sferica
- Lavorata a macchina
- Lente ventilata
- Lente anti-distorsione
- Protezione totale dai raggi uv

### 3 VENTILAZIONE

- A.V.S. Sistema di Ventilazione Ariete
- Filtri aperti

### 4 BANDA ELASTICA

- Altezza 30 mm in stile vintage
- Striscia siliconica anti scivolo
- Sistema doppia fibbia per un rapido aggiustamento della lunghezza dell'elastico

### 5 3 STRATI DI SPUGNA

- Spugne termoformate per un impareggiabile comfort e calzata al viso
- Primo strato di spugna con tecnologia a celle chiuse
- Secondo strato di spugna super morbida con tecnologia a celle aperte
- Terzo strato in pile ipo-allergenico a contatto con la pelle

### ACCESSORI INCLUSI

Custodia in microfibra

## FR

### 1 MONTURE

- Monture mince en style "minimaliste"
- Monture aux proportions moyennes
- Monture ultra legere (67 grammes)

### 2 VERRE

- Verre cat.2
- Spherique
- Usiné
- Verre ventilé
- Verre anti-distorsion
- Protection totale des rayons uv

### 3 VENTILATION

- A.V.S. Systeme de Ventilation Ariete
- Filtres ouverts

### 4 BANDE ELASTIQUE

- Hauteur 30 mm en style vintage
- Bande en silicone anti-glisse
- Systeme de double boucle pour un réglage rapide de la longueur de l'élastique

### 5 3 COUCHES DE MOUSSE

- Mousses thermoformees pour un confort et une vestibilité sur le visage sans egales
- Premiere couche de mousse avec technologie à cellules fermees
- Deuxieme couche de mousse super douce avec technologie à cellules fermees
- Troisieme couche en polaire hypoallegenique en contact avec la peau

### ACCESSOIRES INCLUS

Housse en microfibre

## UK

### 1 FRAME

- Frameless goggles
- Medium Fitment
- Ultra Lightweight (67 grams)

### 2 LENS

- Lens cat.2
- Spherical
- Machined
- Ventilated lens
- Distortion-free lens
- UV rays total protection

### 3 VENT SYSTEM

- A.V.S. Ariete Ventilation System
- Open filters

### 4 ELASTIC STRAP

- 30 mm Height
- Anti-slip silicone bead
- Double buckle for quick adjustment

### 5 3-LAYER FACE FOAM

- 1st technical foam layer with closed cells
- 2nd super-soft technical foam layer with open cells
- 3rd hypo-allergenic pile layer in contact with the skin
- 3D Thermo-formed sponge lining for unmatched comfort and feel

### INCLUDED ACCESSORIES

Microfibre bag

## ES

### 1 MONTURA

- Montura fina estilo "minimal"
- Montura de proporciones medianas
- Montura ultra ligera (67 gramos)

### 2 LENTE

- Lente cat.2
- Esférica
- Elaborada a máquina
- Lente ventilada
- Lente anti-distorsión
- Protección total contra los rayos uv

### 3 VENTILACIÓN

- A.V.S. Sistema de Ventilación Ariete
- Filtros abiertos

### 4 BANDA ELÁSTICA

- Anchura 30 mm estilo vintage
- Banda antideslizante de silicona
- Sistema doble hebilla para ajustar rápidamente la longitud del elástico

### 5 3 CAPAS DE ESPUMA

- Espumas termoformadas para un confort inigualable y perfecta adaptación al rostro
- Primera capa de espuma con tecnología de celdas cerradas
- Segunda capa de espuma súper suave con tecnología de celdas abiertas
- Tercera capa de tejido hipoalergénico al contacto con la piel

### ACCESORIOS INCLUIDOS

Bolsa de microfibra





14920-LNBC

€ 80,00 + IVA/VAT

CAT. 2



SINGLE



14920-LANV

€ 80,00 + IVA/VAT

CAT. 2



SINGLE



14920-LNNO

€ 80,00 + IVA/VAT

CAT. 2



SINGLE



14920-LNBL

€ 80,00 + IVA/VAT

CAT. 2



SINGLE



14920-LGCG

€ 80,00 + IVA/VAT

CAT. 2



SINGLE



14920-LNRA

€ 80,00 + IVA/VAT

CAT. 2



SINGLE

FEATURES

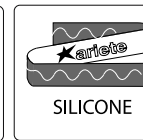
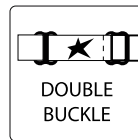
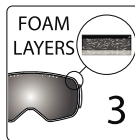
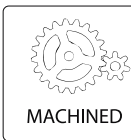
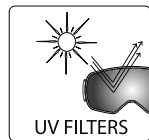

FEATURES

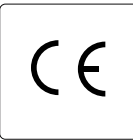

INCLUDED

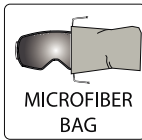



Giorgio De Angelis - Photo VD Photo



ARIETE GOGGLES | 2020



Aspronia - Photo B. Gori



# VINTAGE

## IT

### 1 TELAIO

- Montatura in acciaio cromato
- Imbottitura cucita a mano ed ognuna unica nella sua realizzazione composta da:
- Lato interno a contatto col viso in pelle naturale per garantire un ottimo comfort
- Lato esterno in eco-pelle per essere più resistente agli agenti atmosferici
- Certificata CE

### 2 LENTE

- Lente fumé categoria 2
- Nessuna distorsione ottica
- Miglior trattamento anti-appannamento
- Trattamento anti graffio
- Protezione totale dai raggi UV

### 3 VENTILAZIONE

- Montatura lenti dotata di areazioni perimetrali per un ottima ventilazione

### 4 ELASTICO

- Elastico con 1 linea di silicone antiscivolo
- Elastico da 30 mm in altezza in stile vintage
- Doppia fibbia per regolazione

### ACCESSORI INCLUSI

Custodia in microfibra

## FR

### 1 MONTURE

- Monture en acier chromé
- Rembourrage cousu main, chaque réalisation est unique et se compose de:
- Face interne en contact avec le visage en cuir naturel pour garantir un excellent confort
- Face extérieure en faux cuir pour être plus résistant aux agents atmosphériques
- Certifiée CE

### 2 VERRE

- Verres fumés catégorie 2
- Aucune distorsion optique
- Meilleur traitement antibuée
- Traitement anti-rayure
- Protection totale des rayons UV

### 3 VENTILATION

- Monture avec aérations tout autour pour une excellente ventilation

### 4 ELASTIQUE

- Elastique avec 1 bande en silicone antiglisse
- Elastique de 30 mm de haut en style vintage
- Double boucle de réglage

### ACCESSOIRES INCLUS

Housse en microfibre

## UK

### 1 FRAME

- Steel chrome-plated frame
- Hand made padding composed of:
- Inner surface made from hand-sewn natural leather for unmatched comfort
- Outer surface made of eco-leather treated to provide enhanced weatherproofing
- CE approved

### 2 LENS

- Smoked lenses cat. 2
- No optical distortion
- Best anti-fog treatment
- Anti-scratch treatment
- UV radiations total protection

### 3 VENT SYSTEM

- Frame made of chromium-plated steel with side venting for comfort s

### 4 ELASTIC STRAP

- Elastic strap with 1 anti-slip silicone bead
- 30 mm height elastic strap in pure vintage style
- Double buckle for quick adjustment

### INCLUDED ACCESSORIES

Microfibre bag

## ES

### 1 ESTRUCTURA

- Montura en acero cromado
- Acolchado interior hecho a mano compuesto de:
- Lado interior en contacto con la piel de la cara en piel natural para garantizar un excelente confort
- Lado exterior de eco-piel para ser más resistente a los agentes atmosféricos
- Certificación CE

### 2 LENTE

- Lente de espejo ahumado cat.2
- Mejor tratamiento anti-empañamiento
- Tratamiento anti-rayado
- Sin distorsión óptica
- Protección total contra los rayos UV

### 3 VENTILACIÓN

- Montura con ventilación perimetral para una excelente Ventilación

### 4 ELÁSTICO

- Banda de 30 mm de altura con 1 línea de silicona antideslizante
- Doble hebilla para un ajuste rápido

### ACCESORIOS INCLUIDOS

Bolsa de microfibra



13990-NR

€ 110,<sup>50</sup> + IVA/VAT

CAT. 2 



SINGLE



13990-MC

€ 110,<sup>50</sup> + IVA/VAT

CAT. 2 



SINGLE

FEATURES

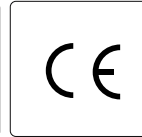
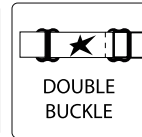
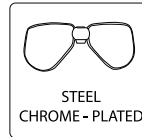
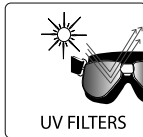

INCLUDED





Aspronia - Photo B. Gori



GOGGLES ARIETE VINTAGE | 2020

# VULCAN GRIPS

IT 1 -Piramidi con base a 3 lati ed a forma variabile:

- micropiramidi nella zona indice/pollice
- piramidi più alte per extra grip nella zona palmare
- piramidi orientate per dare maggiore appoggio in curva nella zona esterna

2 Area di maggior usura rinforzata per aumentare la durata della manopola;

3 Base manopola in materiale semirigido anti-torsione;

4 Fondello predisposto all'asportazione (con guidalama) in caso di uso di paramani chiusi;

5 -4 cave per filo di ferro per serraggio perfetto

UK 1 -Pyramid shapes with a triangular base in varying height:

- micro Pyramids in the thumb/index finger area
- large Pyramids for extra grip in the palm area
- contoured Pyramids in the outer palm area, for extra comfort and support through corners and turns

2 The principle pressure point areas of the grip are reinforced for longevity;

3 Chassis in semi-rigid torque-limited elastomer;

4 Outer flange pre-marked for piercing with a cutting guide for use with all-round hand guards;

5 -four grooves for steel wire give extra security

FR 1 -Grip double densité avec 3 niveaux de grips pyramidales:

- micro-pyramide dans la zone du pouce et de l'index
- pyramides moulées arrondies au niveau de la paume pour plus de confort et de maintien dans les virages
- pyramides larges sur l'extérieur de la poignée pour une adhérence parfaite

2 Grip renforcé pour une meilleure longévité

3 Grip en élastomère semi-rigide

4 Guide de coupe pour une utilisation avec des protège-mains

5 -4 rainures prévues pour un serrage parfait (fil de fer).

ES

1 -Pirámides con base de tres lados y forma variable

- micropirámides en la zona indice/pulgar
- pirámides más altas para agarre extra en la zona de la palma
- pirámides orientadas para dar mayor apoyo en curva en la zona externa

2 Area de mayor desgaste reforzada para aumentar la duración del puño

3 Base del puño en material semi-rigido anti torsión

4 Aleta externa pre-marcada para ser perforada con una guía de corte para ser usado con paramanos

5 -4 canales de alojamiento de alambre para un agarre perfecto

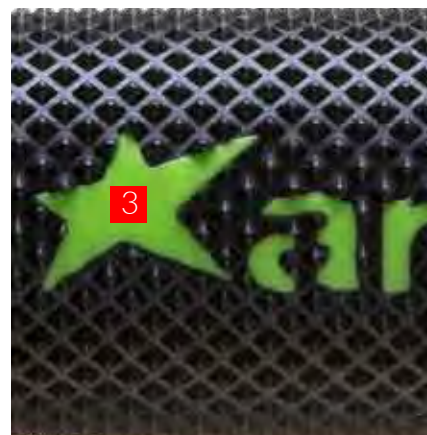

## TECHNOLOGY



02643-ARGR

€ 17,<sup>10</sup> + IVA/VAT



02643-ARN

€ 17,<sup>10</sup> + IVA/VAT



02643-BA

€ 17,<sup>10</sup> + IVA/VAT



02643-GN

€ 17,<sup>10</sup> + IVA/VAT



02643-GRN

€ 17,<sup>10</sup> + IVA/VAT



02643-NB

€ 17,<sup>10</sup> + IVA/VAT



02643-RN

€ 17,<sup>10</sup> + IVA/VAT



02643-VN

€ 17,<sup>10</sup> + IVA/VAT





# TRINITY GRIPS

- IT**
- 1 Base manopola in materiale semirigido anti-torsione
  - 2 Zona palmare in confortevole Supersoft, zona presa dita con specifico rilievo half-waffle
  - 3 Incavo con sagoma anatomica lato destro per pollice ed indice
  - 4 4 cave per filo di ferro per serraggio perfetto
  - 5 La 4°cava è situata all'estremità dell'impugnatura per ridurre l'entrata di impurità tra manopola/manubrio e manopola/comando gas con paramani chiusi
  - 6 Fondello predisposto all'asportazione (con guidalama) in caso di uso di paramani chiusi
  - 7 Flangia maggiorata, internamente rinforzata, rivestita in morbidissimo Xtouch

- UK**
- 1 Chassis in semi-rigid torque-limited elastomer
  - 2 Palm in legendary Supersoft, critical finger-grip area with half-waffle surface
  - 3 Anatomically profiled cut-out on the right side for thumb and forefinger
  - 4 Four grooves for steel wire give extra security
  - 5 The fourth groove is situated at the extreme outer end of the grip to prevent grit from being trapped between bar and grip or bar and twist grip when used with hand guards
  - 6 Outer flange pre-marked for piercing with a cutting guide for use with all-round hand guards
  - 7 Pronounced inner flange with internal reinforcement, coated in extra-soft XTouch

- FR**
- 1 Base de la poignée en matériau semi-rigide anti-torsion
  - 2 Zone palmaire en agréable Supersoft, zone de prise des doigts avec relief spécifique half-waffle
  - 3 Creux anatomique côté droit pour pouce et index
  - 4 4 encoches pour fil de fer pour un serrage parfait
  - 5 la 4ème encoche se trouve à l'extrémité de la poignée afin de réduire l'entrée d'impuretés entre la poignée/guidon et la poignée/commande gaz avec pare mains fermés
  - 6 Culot amovible (avec guide-lame) en cas d'utilisation de pare mains fermés
  - 7 Bride agrandi, renforcée intérieurement, revêtement super souple en Xtouch

- ES**
- 1 Núcleo en material semi-rigido anti-torsión
  - 2 Zona de la palma confortable Supersoft, zona de agarre con relieve específico half-waffle
  - 3 Recorte anatómico perfilado en el lado derecho para el pulgar y el índice
  - 4 4 espacios para facilitar la colocación del alambre de acero para una sujeción perfecta
  - 5 El 4º espacio esta situado en el extremo para evitar que entren impurezas entre el puño/manillar y el puño/ acelerador cuando se montan paramanos cerrados
  - 6 Aleta externa pre-marcada con una guía para facilitar el corte en caso ser usado con paramanos
  - 7 Borde interno aumentado y reforzado, revestido en material extra suave XTouch

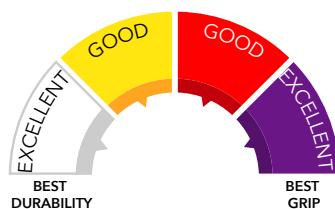

## TECHNOLOGY



02614-GRAR

€ 19,<sup>35</sup> + IVA/VAT



02614-GRRN

€ 19,<sup>35</sup> + IVA/VAT



02614-GRNB

€ 19,<sup>35</sup> + IVA/VAT



02614-BNR

€ 19,<sup>35</sup> + IVA/VAT



02614-GRAN

€ 19,<sup>35</sup> + IVA/VAT



# DUALITY GRIPS



02629-GRN

€ 15,<sup>90</sup> + IVA/VAT



02629-NR

€ 15,<sup>90</sup> + IVA/VAT



02629-NA

€ 15,<sup>90</sup> + IVA/VAT



02629-NAR

€ 15,<sup>90</sup> + IVA/VAT



02629-NG

€ 15,<sup>90</sup> + IVA/VAT



# UNITY SLIMLINE GRIPS



02619 Soft

€ 13,<sup>65</sup> + IVA/VAT



02619/H Medium

€ 13,<sup>65</sup> + IVA/VAT



02619-N Soft

€ 13,<sup>65</sup> + IVA/VAT



# UNITY HALF-WAFFLE GRIPS



02621-N Soft

€ 13,<sup>65</sup> + IVA/VAT



02621/H Medium

€ 13,<sup>65</sup> + IVA/VAT



# UNITY HALF-WAFFLE ASP GRIPS

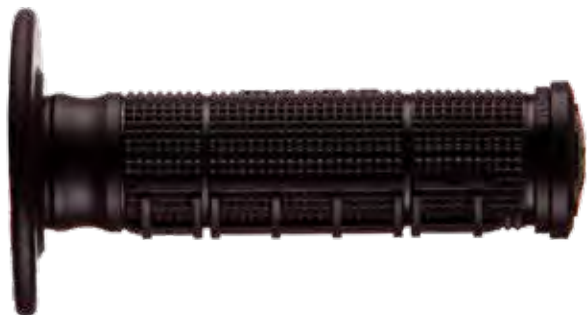

02621/A-N

€ 8,<sup>20</sup> + IVA/VAT

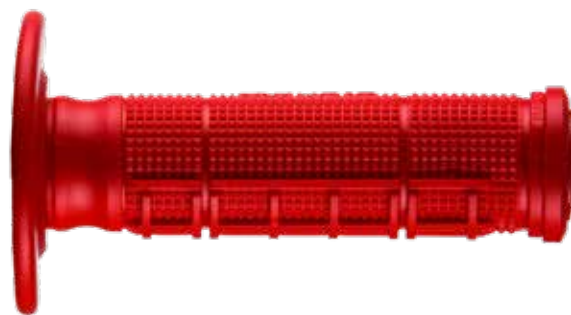

02621/A-R

€ 8,<sup>20</sup> + IVA/VAT



02621/A-A

€ 8,<sup>20</sup> + IVA/VAT

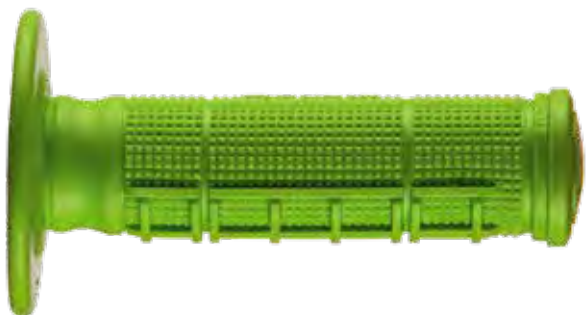

02621/A-L

€ 8,<sup>20</sup> + IVA/VAT



02621/A-GF

€ 8,<sup>20</sup> + IVA/VAT

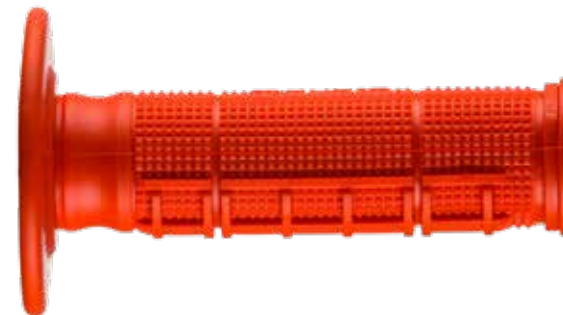

02621/A-AR

€ 8,<sup>20</sup> + IVA/VAT

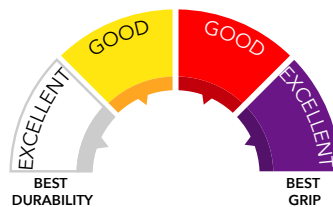



Mattia Cuminetti



KIDS

## YAMAHA PWs - HONDA CRF 50 F OFF-ROAD



02641

€ 7,00 + IVA/VAT



02641-R

€ 7,00 + IVA/VAT



02641-A

€ 7,00 + IVA/VAT



GRIPS AVT-CYCLE



Front

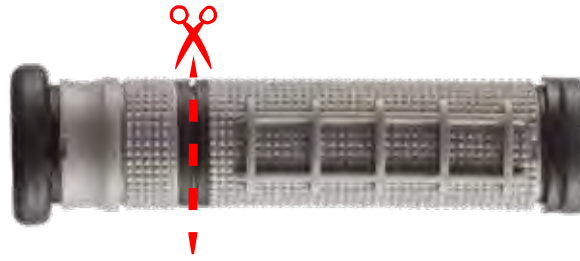

Back



02630-NGR

€ 17,<sup>10</sup> + IVA/VAT



02620

€ 13,<sup>65</sup> + IVA/VAT

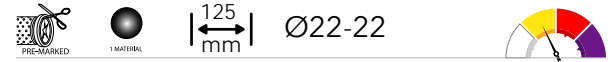

GRIPS TRIAL



01651/SS

€ 16,<sup>10</sup> + IVA/VAT



02617

€ 17,<sup>10</sup> + IVA/VAT



GRIPS RALLY



02616 Tech. Foam + TP Caps € 8,<sup>10</sup> + IVA/VAT



GRIPS CLASSIC MX



01671

€ 6,<sup>90</sup> + IVA/VAT



BRAKE LOCK

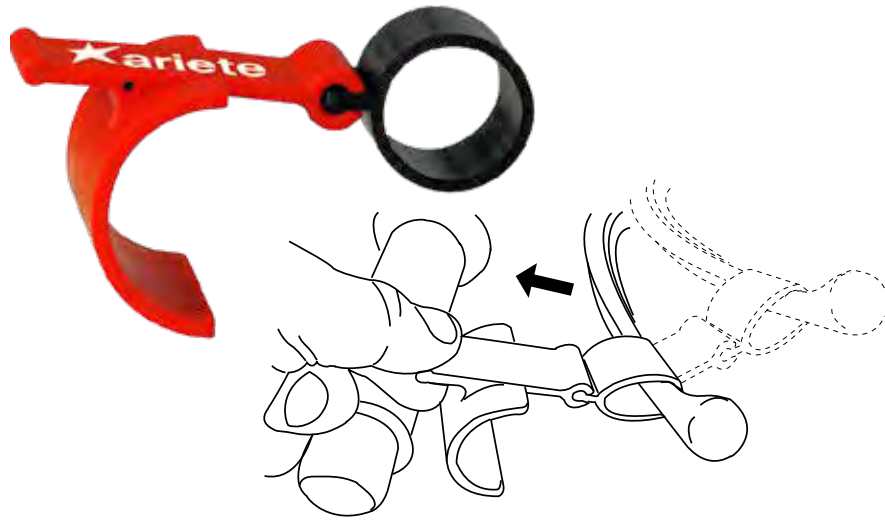

12951

€ 9,<sup>90</sup> + IVA/VAT

BIG FOOT Pack 10 pcs.



11993 Pack 10 pcs.

€ 31,<sup>65</sup> + IVA/VAT

11993-R Pack 10 pcs.

€ 31,<sup>65</sup> + IVA/VAT



SIDE STAND

MUD SCRAPER

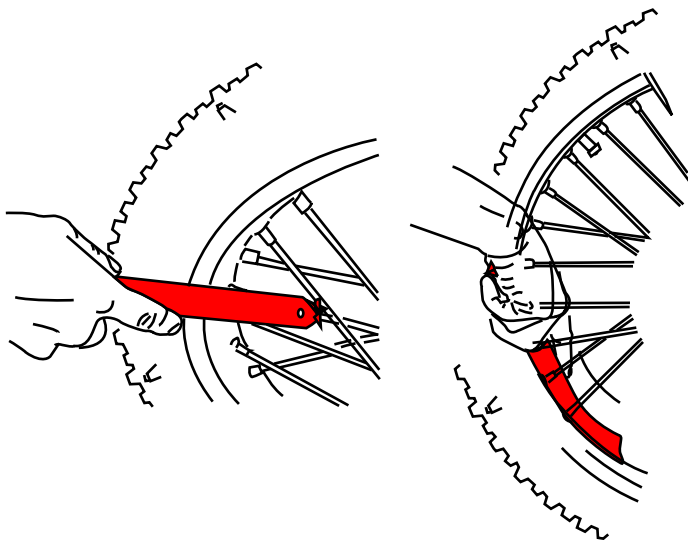

12952

€ 10,<sup>25</sup> + IVA/VAT

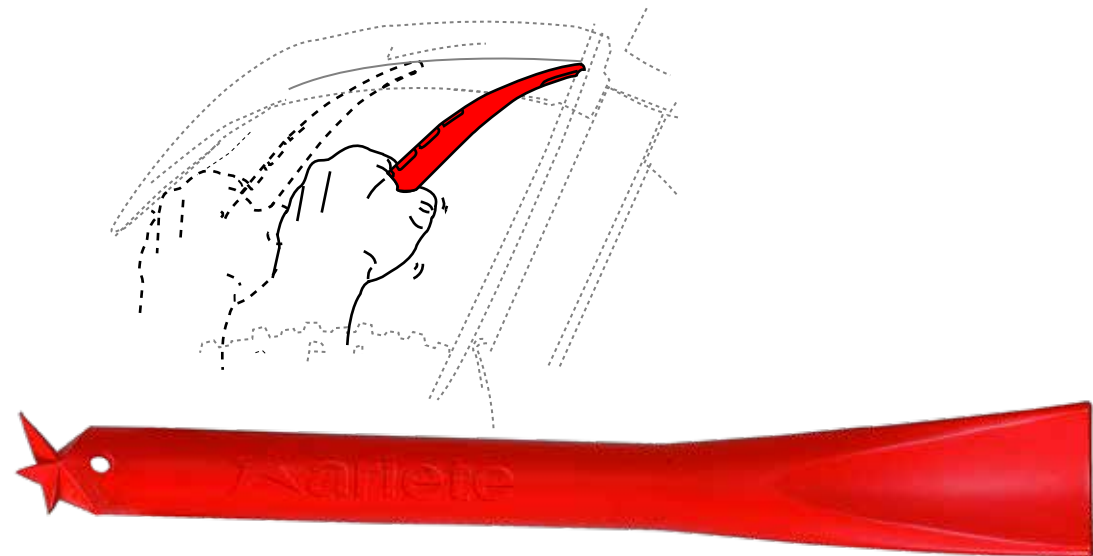



SUPER FAST GRIP GLUE 20gr.



12992

€ 14,<sup>65</sup> + IVA/VAT

- IT Fissaggio da 30 a 90 secondi, alta viscosità
- UK Dries in 30 to 90 seconds, high viscosity
- FR Fixation entre 30 et 90 secondes, haute viscosité
- ES Fijación de 30 a 90 segundos, alta viscosidad



10936

€ 7,<sup>20</sup> + IVA/VAT

- IT Tubo sfiato tappo serbatoio - con valvola
- UK Tank breather vent pipe - Air valve included
- FR Tuyau de ventilation bouchon de réservoir - Avec soupape intégrée
- ES Tubo de ventilación del respiradero del tanque - Válvula incluida

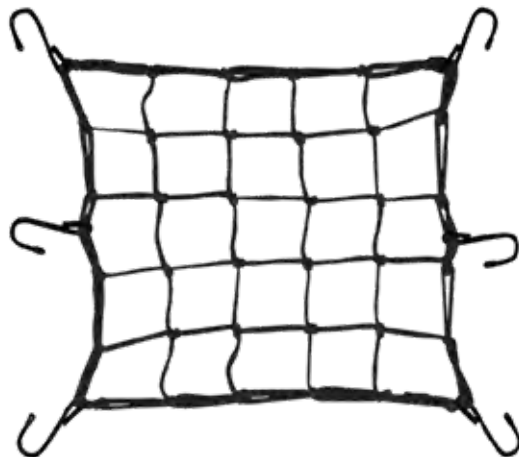

09957

€ 11,<sup>30</sup> + IVA/VAT



- 10915 1,60"
- 10916 1,85"
- 10917 2,15"

10915 1,60"

€ 15,<sup>70</sup> + IVA/VAT

10916 1,85"

€ 16,<sup>95</sup> + IVA/VAT

10917 2,15"

€ 18,<sup>35</sup> + IVA/VAT



10901

10901 Ø 19-38



13904

13904 Ø 24-48

€ 4,<sup>40</sup> + IVA/VAT

€ 5,<sup>10</sup> + IVA/VAT



RACING

<b>12949/S</b>	<b>silicone</b>	5000 Ohm High performance ø 6,3	OPTIMIZED ★★★★★
<b>12949</b>	<b>EPDM</b>		



12949/S  
silicone

12949/S

€ 8,00 + IVA/VAT

€ 5,00 + IVA/VAT

12949

€ 5,00 + IVA/VAT

12949

€ 5,00 + IVA/VAT



04999 small ø 3,9  
silicone  
04999/A standard ø 6,3  
silicone



04999 ø 3,9

€ 16,90 + IVA/VAT

04999/A ø 6,3

€ 16,90 + IVA/VAT



09965  
silicone



09965-A  
silicone







09965 /A  
silicone

09965 ø 6,3 min. 5 pcs. € 5,35 + IVA/VAT

09965-A ø 6,3 min. 5 pcs. € 5,35 + IVA/VAT

09965 /A ø 6,3 min. 5 pcs. € 5,35 + IVA/VAT

	Ø TUBE	Ø SLIDER	L. MIN	L. MAX	COLOUR	CODE	PRICE
	28/30	46/48	50	215	Black	<b>07907</b>	€ 14,95
	28/32	52/54	55	310	Black	<b>09941</b>	€ 23,50
	32/34	52/54	65	250	Black	<b>06962</b>	€ 18,80
	33/38	50/55	100	335	Black	<b>09942/A</b>	€ 26,60
	33/38	50/55	100	335	Blue	<b>09942/A-A</b>	€ 26,60
	35/38	56/59	85	440	Black	<b>09943</b>	€ 26,00
	35/38	56/60	85	440	Black	<b>07901</b>	€ 20,70
	38/41	58/62	95	430	Black	<b>07995</b>	€ 27,20
	38/41	58/62	95	430	Blue	<b>07995-A</b>	€ 27,20
	38/41	58/62	95	430	Red	<b>07995-R</b>	€ 27,20
	39/41	58/60	105	290	Black	<b>09981</b>	€ 39,60
	40/43	57/60	75	500	Black	<b>09932</b>	€ 26,90
	40/43	57/60	75	500	Blue	<b>09932-A</b>	€ 26,90
	40/43	57/60	75	500	Red	<b>09932-R</b>	€ 26,90
	43/45	57/60	70	240	Black	<b>09974</b>	€ 20,90
	43/46	58/63	90	600	Black	<b>09950</b>	€ 36,00





# ARIRAM GRIPS

- IT
- 1 Forma cilindrica a spessore costante;
  - 2 Base manopola in materiale semirigido anti-torsione;
  - 3 Zona palmare confortevole e liscia, extra grip nella zona retro delle dita;
  - 4 Fondello conico ottimizzato per i bilancieri;
  - 5 Progettata per il massimo controllo ed assorbire le vibrazioni;
  - 6 4 cave per il filo di ferro per un serraggio perfetto

- UK
- 1 Cylindrical shape with consistent parallel wall thickness;
  - 2 Chassis in semi-rigid torque-limited elastomer;
  - 3 Smooth and comfortable palm area with textured finger grip on opposite face;
  - 4 Conical base to accommodate bar end weights;
  - 5 Cleverly-designed to give exceptional grip and absorb vibration;
  - 6 Four grooves for steel wire give extra security

- FR
- 1 Grip de forme cylindrique à épaisseur constante
  - 2 Grip en élastomère semi-rigide
  - 3 Zone lisse et confortable au niveau de la paume avec une légère zone de grip sur la partie arrière
  - 4 Grip avec embout conique pour une parfaite adaptation avec les embouts de guidon
  - 5 Grip issu de la recherche et développement Ariete, garantissant une adhérence exceptionnelle et une parfaite absorption des vibrations
  - 6 4 rainures prévues pour un serrage parfait (fil de fer).

- ES
- 1 Forma cilíndrica de espesor constante
  - 2 Base del puño en material semi-rígido anti torsión
  - 3 Zona de la palma confortable y lisa. Agarre extra en la zona trasera de los dedos
  - 4 Fondo cónico optimizado para los contrapesos
  - 5 Proyectado para el máximo control y absorción de vibraciones
  - 6 4 canales de alojamiento de alambre para un agarre perfecto

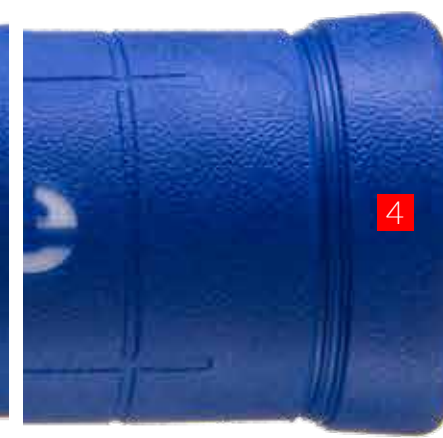
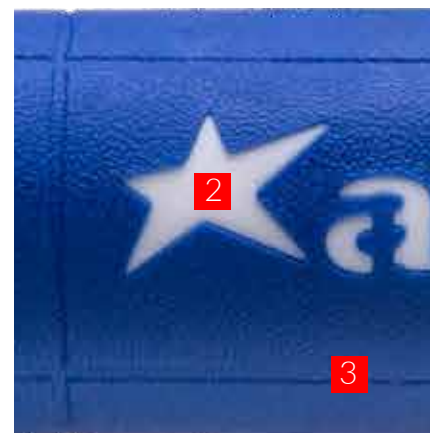

## TECHNOLOGY



02642-RN

€ 17,<sup>10</sup> + IVA/VAT



02642-ARN

€ 17,<sup>10</sup> + IVA/VAT



02642-BA

€ 17,<sup>10</sup> + IVA/VAT



02642-GN

€ 17,<sup>10</sup> + IVA/VAT



02642-GRN

€ 17,<sup>10</sup> + IVA/VAT



02642-NG

€ 17,<sup>10</sup> + IVA/VAT



02642-NR

€ 17,<sup>10</sup> + IVA/VAT



02642-VN

€ 17,<sup>10</sup> + IVA/VAT



# ARIES GRIPS

- IT**
- 1 Scanalature integrate con spazio per fissare il filo di ferro
  - 2 Flangia conica esterna per presa laterale
  - 3 Disegno a piramide a punta acuta
  - 4 Stampo inciso con tecnologia laser
  - 5 Ottimizzata per il comando gas
  - 6 Corpo manopola sottile
  - 7 Ottimizzata per il montaggio dei bilanciери

- UK**
- 1 Built-in wire-on grooves with space to tighten the wire
  - 2 Outer flange for lateral grip
  - 3 Acute pyramid edges
  - 4 Laser engineered mold
  - 5 Optimized for throttle pipe
  - 6 Slimline shape
  - 7 Optimized for bar weights

- FR**
- 1 Rainures intégrées pour fixer le fil de fer
  - 2 Bride conique extérieure pour prise latérale
  - 3 Dessin à pyramide pointue
  - 4 Moule gravée avec technologie
  - 5 Optimisée pour commande gaz
  - 6 Corpo poigné fin
  - 7 Optimisée pour le montage des culbuteurs

- ES**
- 1 Canales para facilitar el ajuste de alambre de fijación
  - 2 Lengüeta exterior cónica para agarre lateral
  - 3 Puntos de agarre en punta piramidal
  - 4 Molde realizado mediante ingeniería láser
  - 5 Optimizado para mando de gas
  - 6 Bajo espesor
  - 7 Optimizado para uso de contrapesos

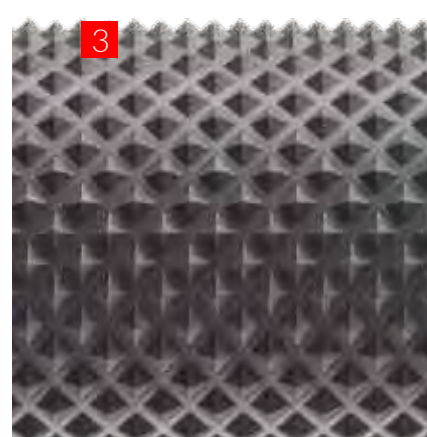
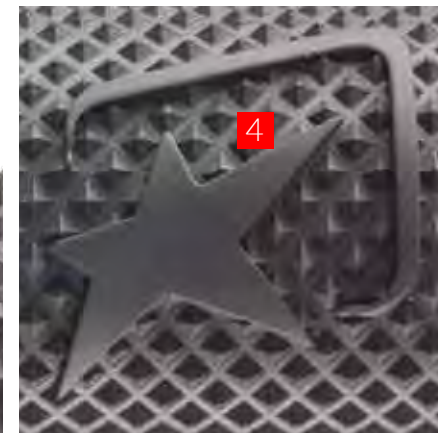
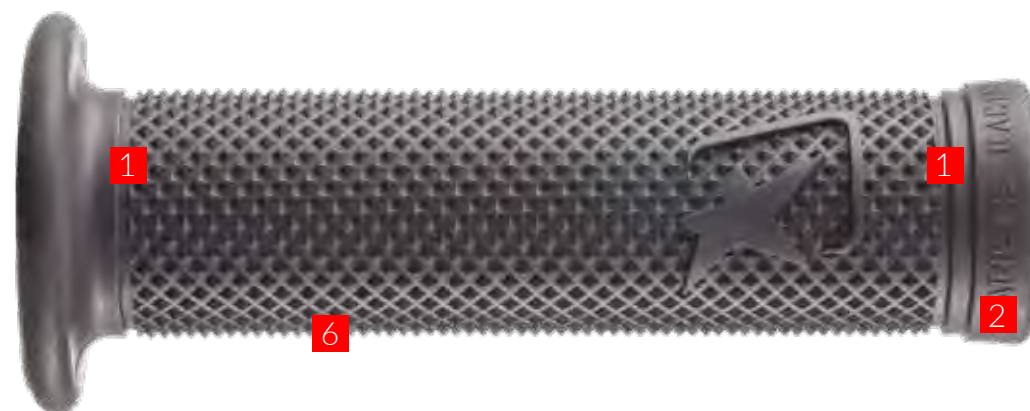
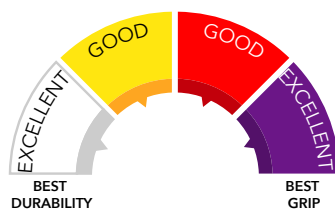

## TECHNOLOGY



02636 Soft € 15,<sup>35</sup> + IVA/VAT







02636/H Medium € 15,<sup>35</sup> + IVA/VAT









02636-N Soft € 15,<sup>35</sup> + IVA/VAT



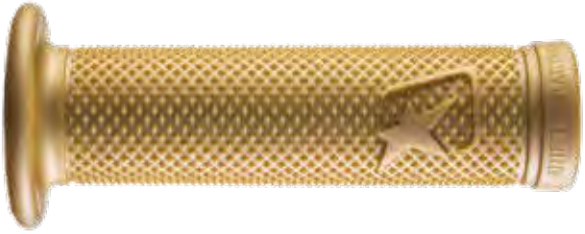

02636/Gold Medium € 15,<sup>35</sup> + IVA/VAT







02636/C-N Soft € 15,<sup>35</sup> + IVA/VAT





ESTORIL ROAD GRIPS

SUPERBIKE GEL



02615-SBK Super soft € 17,<sup>10</sup> + IVA/VAT







02615-A Soft € 17,<sup>10</sup> + IVA/VAT







02615-R Soft € 17,<sup>10</sup> + IVA/VAT









# STANDARD GRIPS



02640/SSF

€ 15,<sup>35</sup> + IVA/VAT



01663/SSF

€ 16,<sup>10</sup> + IVA/VAT



02637/SSF

€ 15,<sup>35</sup> + IVA/VAT



01661/SSF

€ 16,<sup>10</sup> + IVA/VAT



01686/SSF

€ 15,<sup>35</sup> + IVA/VAT



01681/SSF

€ 15,<sup>35</sup> + IVA/VAT



01685/SSF

€ 15,<sup>35</sup> + IVA/VAT



01686/SS

€ 15,<sup>35</sup> + IVA/VAT

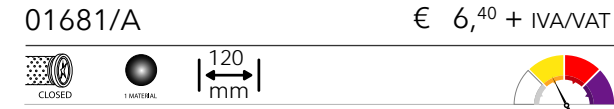

01681/A

€ 6,<sup>40</sup> + IVA/VAT



# STANDARD GRIPS



01680/SSF

€ 15,<sup>35</sup> + IVA/VAT



01694/SSF

€ 15,<sup>35</sup> + IVA/VAT



01679/SSF

€ 15,<sup>35</sup> + IVA/VAT



02623/SSF

€ 15,<sup>35</sup> + IVA/VAT



02625/SSF

€ 15,<sup>35</sup> + IVA/VAT



02639/SSF

€ 15,<sup>35</sup> + IVA/VAT



# STANDARD GRIPS



02626/SSF € 15,<sup>35</sup> + IVA/VAT



02626/SS € 15,<sup>35</sup> + IVA/VAT



02626/A/F € 8,<sup>00</sup> + IVA/VAT



02626/A € 8,<sup>00</sup> + IVA/VAT



01682/SSF € 15,<sup>35</sup> + IVA/VAT



01616 Foam Plus + TP Caps € 10,<sup>20</sup> + IVA/VAT



02636 € 15,<sup>35</sup> + IVA/VAT

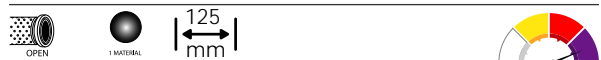

02636/H € 15,<sup>35</sup> + IVA/VAT



02636-N € 15,<sup>35</sup> + IVA/VAT



02636/C-N € 15,<sup>35</sup> + IVA/VAT



# STANDARD GRIPS



01690/F € 19,<sup>45</sup> + IVA/VAT



02613-N € 14,<sup>80</sup> + IVA/VAT



01612 € 13,<sup>25</sup> + IVA/VAT



02638/SSF € 15,<sup>35</sup> + IVA/VAT



01612/SS € 16,<sup>20</sup> + IVA/VAT



13917 Foam Grips Cover € 7,<sup>50</sup> + IVA/VAT





EST. 1947  
*Ariete Heritage*  
GRIPS COLLECTION

Marco Belli Photo @marcorenieri

GRIPS ARIETE HERITAGE | 2020



# ARIETE HERITAGE GRIPS



00680-CFN € 19,<sup>30</sup> + IVA/VAT

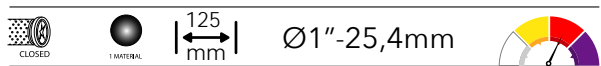

00680-CFR € 19,<sup>30</sup> + IVA/VAT

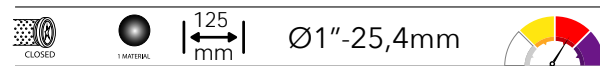

00680-CFM € 19,<sup>30</sup> + IVA/VAT

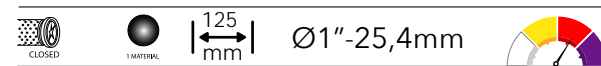

01628-CFN € 19,<sup>30</sup> + IVA/VAT



01628-CFR € 19,<sup>30</sup> + IVA/VAT



01628-CFM € 19,<sup>30</sup> + IVA/VAT



01604-CFN € 19,<sup>30</sup> + IVA/VAT



01604-CFR € 19,<sup>30</sup> + IVA/VAT



01604-CFM € 19,<sup>30</sup> + IVA/VAT



# ARIETE HERITAGE GRIPS

EST. 1947  
*Ariete Heritage*  
GRIPS COLLECTION

GRIPS ARIETE HERITAGE | 2020



00691-CFN € 19,<sup>30</sup> + IVA/VAT



00691-CFR € 19,<sup>30</sup> + IVA/VAT



00691-CFM € 19,<sup>30</sup> + IVA/VAT



01683-CFN € 19,<sup>30</sup> + IVA/VAT



01683-CFR € 19,<sup>30</sup> + IVA/VAT



01683-CFM € 19,<sup>30</sup> + IVA/VAT



01621-CFN € 19,<sup>30</sup> + IVA/VAT



01621-CFR € 19,<sup>30</sup> + IVA/VAT



01621-CFM € 19,<sup>30</sup> + IVA/VAT





# ARIETE HERITAGE GRIPS

ROAD



01617/A-P

€ 19,<sup>30</sup> + IVA/VAT



01617/A

€ 19,<sup>30</sup> + IVA/VAT



01617-CFN

€ 19,<sup>30</sup> + IVA/VAT



ROAD

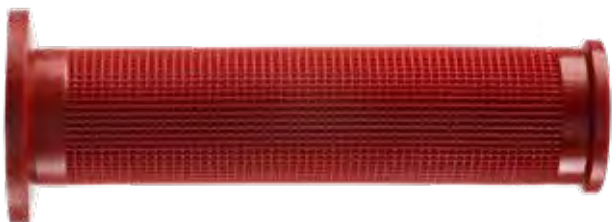

01617/A-R

€ 19,<sup>30</sup> + IVA/VAT



01617-CFR

€ 19,<sup>30</sup> + IVA/VAT



01617-CFM

€ 19,<sup>30</sup> + IVA/VAT

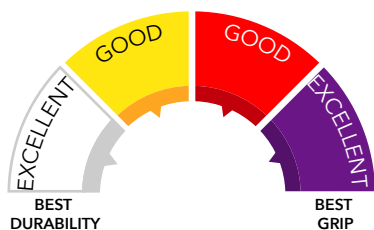

Right grip, rear side



Front side

# ARIETE HERITAGE GRIPS

EST. 1947  
*Ariete Heritage*  
GRIPS COLLECTION

GRIPS ARIETE HERITAGE | 2020

VEGA ROAD



01629-CFN

€ 19,<sup>30</sup> + IVA/VAT

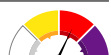

01629-CFR

€ 19,<sup>30</sup> + IVA/VAT

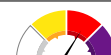

01629-CFM

€ 19,<sup>30</sup> + IVA/VAT



OFF-ROAD



00699-CFN

€ 19,<sup>30</sup> + IVA/VAT

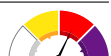

00699-CFR

€ 19,<sup>30</sup> + IVA/VAT

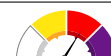

00699-CFM

€ 19,<sup>30</sup> + IVA/VAT

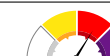

ROAD



00692-CFN

€ 19,<sup>30</sup> + IVA/VAT

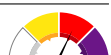

00692-CFR

€ 19,<sup>30</sup> + IVA/VAT

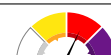

00692-CFM

€ 19,<sup>30</sup> + IVA/VAT

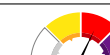

# SUITABLE FOR BMW GRIPS



02624/L Ø26-26 € 19,<sup>45</sup> + IVA/VAT

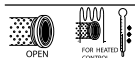

for heated controls till -->2013



02624/C Ø26-26 € 19,<sup>45</sup> + IVA/VAT



for heated controls till -->2013



02624/LN Ø26-26 € 19,<sup>45</sup> + IVA/VAT

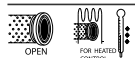

for heated controls, for multi-controller navigator system since 2014-->



01690/F Ø22-26 € 19,<sup>45</sup> + IVA/VAT

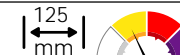

01690/F/24 Ø26-26 € 19,<sup>45</sup> + IVA/VAT



for heated controls



01690/F24N Ø26-26 € 19,<sup>45</sup> + IVA/VAT

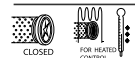

for heated controls, for multi-controller navigator system



02634 *Old Models* Ø22-26 Rubber € 25,<sup>50</sup> + IVA/VAT



for K Series since -----> 1977

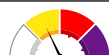

**SUITABLE FOR  
MULTI-CONTROLLER  
NAVIGATOR SYSTEM**



# SUITABLE FOR BMW

TELELEVER BMW BOXER

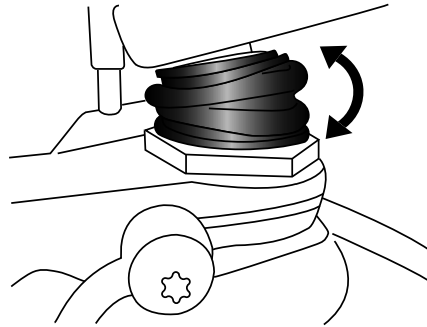

IT Cuffia snodo  
 UK Ball joint boot  
 FR Soufflet de protection  
 ES Uelle rotula direcci3n

13911

€ 14,<sup>10</sup> + IVA/VAT

**BMW CC. : 850, 1100, 1150, 1200 BMW SERIES: R, RS, RT, S, GS, GS ADVENTURE**



09974

€ 20,<sup>90</sup> + IVA/VAT

PAIR FORK GAITERS K100

**EPDM HP**  
*Special Compound*

IT Guarnizioni pinza freno  
 UK Brake calipers Seal kit  
 FR Garnitures pour fourches pour freins  
 ES Juntas de pinzas de freno

BRAKE CALIPERS SEAL KIT



13855-PI

€ 21,<sup>75</sup> + IVA/VAT

**BMW SERIES: R65 (85-95), R80 (81-95), R100 (77-84)  
 R1100 (92-2001), K75 (85-95), K100 (83-92), K1100 (92-96)**



13919

€ 7,<sup>00</sup> + IVA/VAT

SILENTBLOCK M/M 8MA



13918

€ 5,<sup>00</sup> + IVA/VAT

SILENTBLOCK 25/15 M/F 6MA

# SUITABLE FOR HONDA GRIPS



02640/SSF € 15,<sup>35</sup> + IVA/VAT



02637/SSF € 15,<sup>35</sup> + IVA/VAT



01687-C2R € 22,<sup>20</sup> + IVA/VAT



01661/SSF € 16,<sup>10</sup> + IVA/VAT



01686/SSF € 15,<sup>35</sup> + IVA/VAT



01682/SSF € 15,<sup>35</sup> + IVA/VAT



01612 € 13,<sup>25</sup> + IVA/VAT



01612/SS € 16,<sup>20</sup> + IVA/VAT



01686/SS € 15,<sup>35</sup> + IVA/VAT



09981 € 39,<sup>50</sup> + IVA/VAT

PAIR FORK GAITERS TRANSALP 600

# SUITABLE FOR KAWASAKI GRIPS



01685/SSF

€ 15,<sup>35</sup> + IVA/VAT



01679/SSF

€ 15,<sup>35</sup> + IVA/VAT



02625/SSF

€ 15,<sup>35</sup> + IVA/VAT



01687-NJ

€ 22,<sup>20</sup> + IVA/VAT



01687-ZX

€ 22,<sup>20</sup> + IVA/VAT



# SUITABLE FOR YAMAHA GRIPS



01663/SSF € 16,<sup>10</sup> + IVA/VAT



01687-R1 € 22,<sup>20</sup> + IVA/VAT



01694/SSF € 15,<sup>35</sup> + IVA/VAT



01681/SSF € 15,<sup>35</sup> + IVA/VAT



02626/SSF 02626/SS € 15,<sup>35</sup> + IVA/VAT



02638/SSF € 15,<sup>35</sup> + IVA/VAT



01681/A € 6,<sup>40</sup> + IVA/VAT



02626/A/F 02626/A € 8,<sup>00</sup> + IVA/VAT



07907 € 14,<sup>95</sup> + IVA/VAT

PAIR OF FORK GAITERS DT 125

# SUITABLE FOR YAMAHA GRIPS

YAMAHA PW 50



02641

€ 7,00 + IVA/VAT



02641-R

€ 7,00 + IVA/VAT



02641-A

€ 7,00 + IVA/VAT



# SUITABLE FOR SUZUKI GRIPS



01685/SSF

€ 15,35 + IVA/VAT



01679/SSF

€ 15,35 + IVA/VAT



01687-GSRA

€ 22,20 + IVA/VAT



# SUITABLE FOR KYMCO GRIPS



02639/SSF

€ 15,35 + IVA/VAT



GRIPS BY BRAND | 2020





# SCOOTER GRIPS

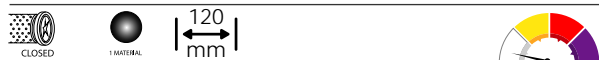

01678

€ 7,<sup>50</sup> + IVA/VAT

01683

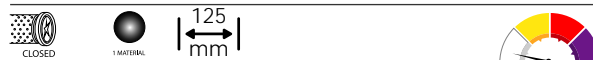
€ 8,<sup>80</sup> + IVA/VAT

01683-M

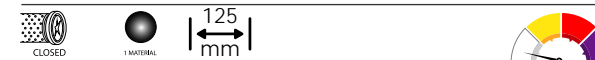
€ 9,<sup>70</sup> + IVA/VAT

01609/V Vespa

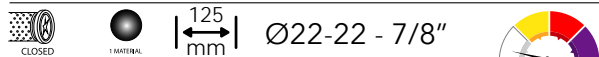
€ 6,<sup>10</sup> + IVA/VAT

01626/V Vespa

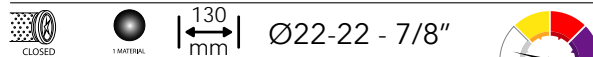
€ 7,<sup>25</sup> + IVA/VAT

01670

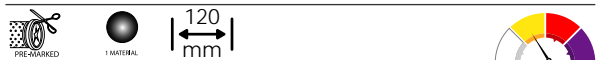
€ 6,<sup>90</sup> + IVA/VAT

01670-A

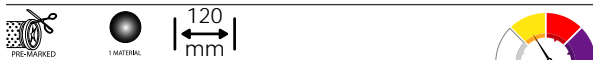
€ 6,<sup>90</sup> + IVA/VAT

01668/A

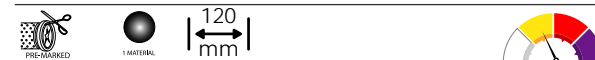
€ 6,<sup>70</sup> + IVA/VAT

# ARIES ASP GRIPS



02636/A/FA € 8,<sup>20</sup> + IVA/VAT



02636/A-A € 8,<sup>20</sup> + IVA/VAT



02636/AFGF € 8,<sup>20</sup> + IVA/VAT



02636/A-GF € 8,<sup>20</sup> + IVA/VAT



02636/A/FN € 8,<sup>20</sup> + IVA/VAT



02636/A-N € 8,<sup>20</sup> + IVA/VAT



02636/A/FR € 8,<sup>20</sup> + IVA/VAT



02636/A-R € 8,<sup>20</sup> + IVA/VAT



FLUO COLOR



# SCOOTER ASP GRIPS



01686/A-N € 8,<sup>20</sup> + IVA/VAT



01686/A/FN € 8,<sup>20</sup> + IVA/VAT



01686/A-A € 8,<sup>20</sup> + IVA/VAT



01686/A/FA € 8,<sup>20</sup> + IVA/VAT



01686/A-R € 8,<sup>20</sup> + IVA/VAT



01686/A/FR € 8,<sup>20</sup> + IVA/VAT

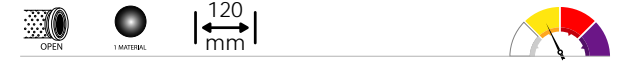

01686/A-GF € 8,<sup>20</sup> + IVA/VAT



01686/A/FGF € 8,<sup>20</sup> + IVA/VAT



01686/A-OF € 8,<sup>20</sup> + IVA/VAT



01686/A/FOF € 8,<sup>20</sup> + IVA/VAT



# SCOOTER ASP GRIPS



02605/A/FN

€ 8,<sup>20</sup> + IVA/VAT



02605/A/FA

€ 8,<sup>20</sup> + IVA/VAT



02605/A/FR

€ 8,<sup>20</sup> + IVA/VAT



02605/AFGF

€ 8,<sup>20</sup> + IVA/VAT



02605/AFOF

€ 8,<sup>20</sup> + IVA/VAT

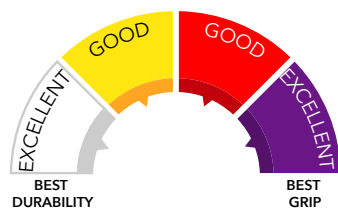

REAR SIDE

FRONT SIDE

# HARRI'S ROAD GRIPS



01687-HRR € 22,<sup>20</sup> + IVA/VAT



01687-HRGR € 22,<sup>20</sup> + IVA/VAT



01687/F-NC € 22,<sup>20</sup> + IVA/VAT



01687-NC € 22,<sup>20</sup> + IVA/VAT



01687 € 22,<sup>20</sup> + IVA/VAT



01687/F € 22,<sup>20</sup> + IVA/VAT



01687/LF € 22,<sup>20</sup> + IVA/VAT



# PUZZLE TANK PROTECTORS

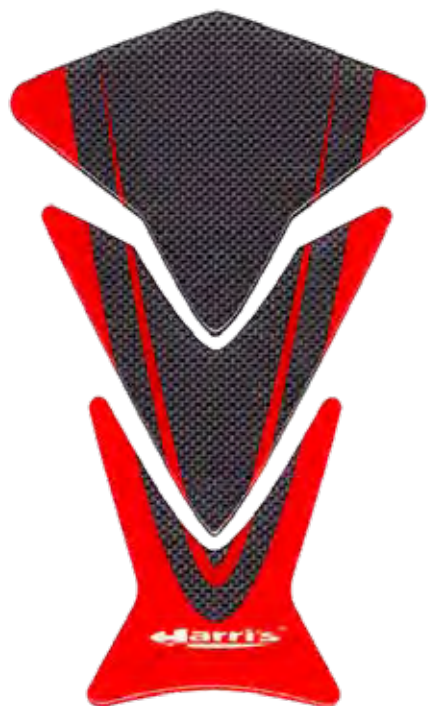

12970-R € 17,<sup>10</sup> + IVA/VAT



12970 € 17,<sup>10</sup> + IVA/VAT



12970-T € 17,<sup>10</sup> + IVA/VAT

Trasparente - Transparent

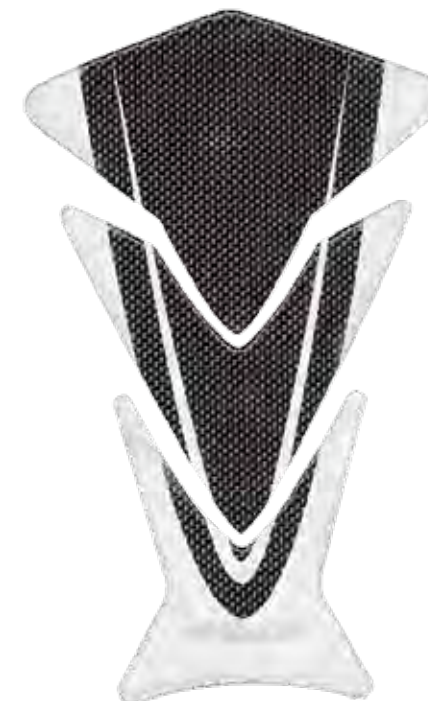

12970-TR € 17,<sup>10</sup> + IVA/VAT

Trasparente - carbonio  
Transparent - carbon look

IT - Resinatura trasparente resistente ai raggi UV - Materiale antigraffio e durevole - Adesivo di alta qualità (non danneggia la vernice del serbatoio)

UK - Perfectly UV-resistant transparent resin - Anti-scratch and long-lasting material - Top quality adhesive (no damage to fuel tank)

FR - Résine parfaitement transparente et résistante aux rayons UV - Matériel anti-rayures et durable - Support adhésif de haute qualité (qui n'endommage pas le vernis)

ES - Resina transparente resistente a los rayos UV - Material anti-rayas y resiste el paso del tiempo - Material adhesivo de altísima calidad (no daña la pintura del depósito)

# RACING VALVES FOR TUBELESS

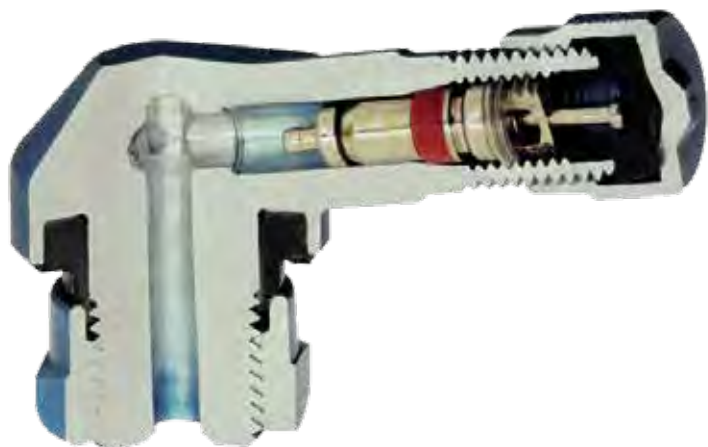

- IT** - Valvola di sicurezza in alluminio per pneumatici tubeless  
 - L'angolazione a 90° permette l'accesso durante il gonfiaggio  
 - Mantiene la pressione del pneumatico  
 - Conf. 2 pezzi
- UK** - Safety valve in aluminium for tubeless wheels  
 - Practical access for inflation  
 - No loss of pressure in the tyre  
 - Sold in pairs
- FR** - Valve de sécurité en aluminium pour tubeless  
 - L'inclinaison résout complètement les problèmes d'accès au gonflage  
 - Maintient la pression des pneus  
 - Vendu par paires
- ES** - Válvula de seguridad en aluminio para neumáticos sin cámara  
 - La inclinación de la válvula a 90° permite un práctico acceso para el hinchado  
 - Mantiene la presión del neumático  
 - Se venden por pares

TUV TA - MAN - 9084/03

**cod.11970= Ø 11,3 STANDARD RIMS**

**cod.11971= Ø 8,3 SPECIAL RIMS Antera, Brembo, Marchesini, Marvic, OZ Racing**



11970-GOLD € 30,<sup>75</sup> + IVA/VAT

Ø 11,3

11970-R € 30,<sup>75</sup> + IVA/VAT

Ø 11,3

11970 € 30,<sup>75</sup> + IVA/VAT

Ø 11,3

11971-N € 30,<sup>75</sup> + IVA/VAT

Ø 8,3

11970-N € 30,<sup>75</sup> + IVA/VAT

Ø 11,3

11971-ALL € 30,<sup>75</sup> + IVA/VAT

Ø 8,3

11970-ALL € 30,<sup>75</sup> + IVA/VAT

Ø 11,3

# ARI<sup>®</sup>

THE ORIGINAL  
FORK OIL SEALS

 **ariete**<sup>®</sup>



# ARI THE ORIGINAL FORK OIL SEALS

**AVOID ARI SEAL FAKES** 7 STEPS TO IDENTIFY AN ORIGINAL ARI BY ARIETE



FINE GROUND MATT INNER LIP, NO FLASH



STEEL SPRING



ARIETE NAME ON EVERY SEAL



# ARI THE ORIGINAL FORK OIL SEALS

IT L'anello di tenuta paraolio di **Ariete** è il top esistente nel mercato per l'alta qualità dei materiali utilizzati e l'elevatissimo grado di finitura.

La linea **ARI** con oltre 170 tipi diversi equipaggia più di 35.000 modelli di moto con forcelle tradizionali e rovesciate (USD) dal funzionamento teleidraulico degli anni 60 a quello pneumatico (Aria) sempre più attuale nel mondo Off-Road. **ARI**, il paraolio di **Ariete** sinonimo di perfezione assoluta.

UK **Ariete** fork oil-seals are the best you can get. This claim is justified by the quality of the materials used, and attention to detail in their design and manufacture.

The **ARI** range has more than 170 different seal sizes. These cover more than 35,000 different motorcycle models with both traditional and upside-down forks. We have seals for classic 1960s telescopic forks extending through to the air forks now common both on- and off-road.

**ARI** fork oil-seals - perfection, from **Ariete**.

FR Le Joint Spy de **Ariete** représente le top sur le marché pour la haute qualité des matériaux utilisés et le degré de finition très élevé.

La gamme **ARI** avec ses 170 différents types équipe plus de 35.000 modèles de motos avec fourches soit traditionnels qu'inversées (USD) du fonctionnement télé-hydraulique des Années '60 au fonctionnement pneumatique (Air) de plus en plus actuel dans le monde Off-Road. **ARI**, le Joint Spy de **Ariete** synonyme de perfection absolue.

ES El retén de horquilla **Ariete** representa el máximo nivel alcanzado en el mercado existente gracias a la alta calidad de los materiales utilizados y también al alto grado de acabado.

La línea **ARI**, con más de 170 tipos diferentes equipa a más de 35.000 modelos de motocicletas con horquillas convencionales y telescópicas invertidas (USD), desde aquellas de funcionamiento hidráulico de los años '60 hasta las de funcionamiento neumático (Aire) cada vez más presentes en el mundo Off-Road. **ARI**, el retén de **Ariete** sinónimo de perfección absoluta.

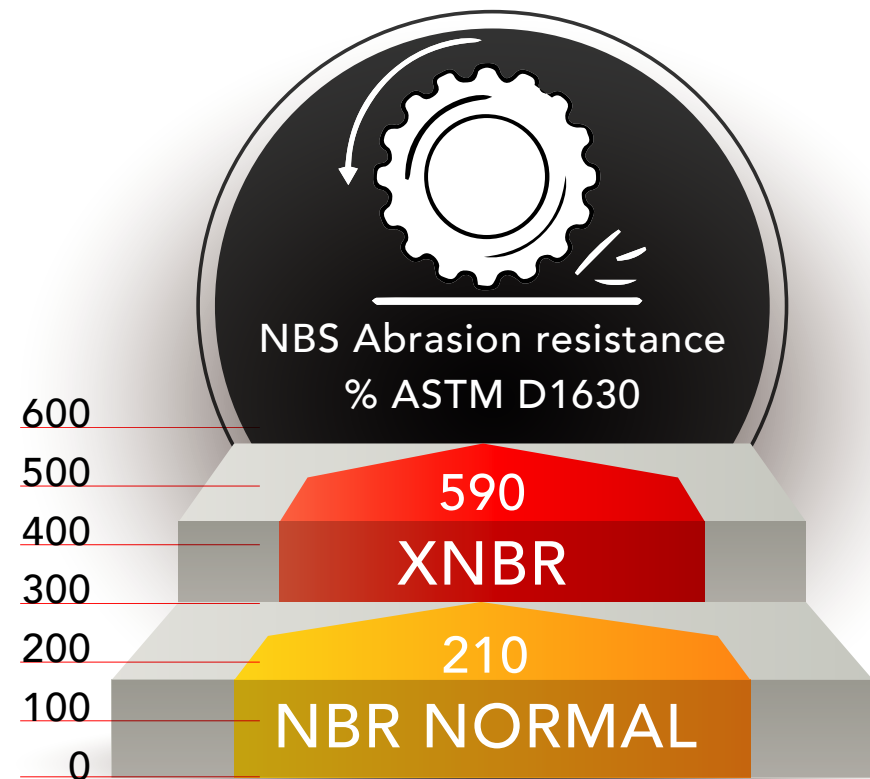
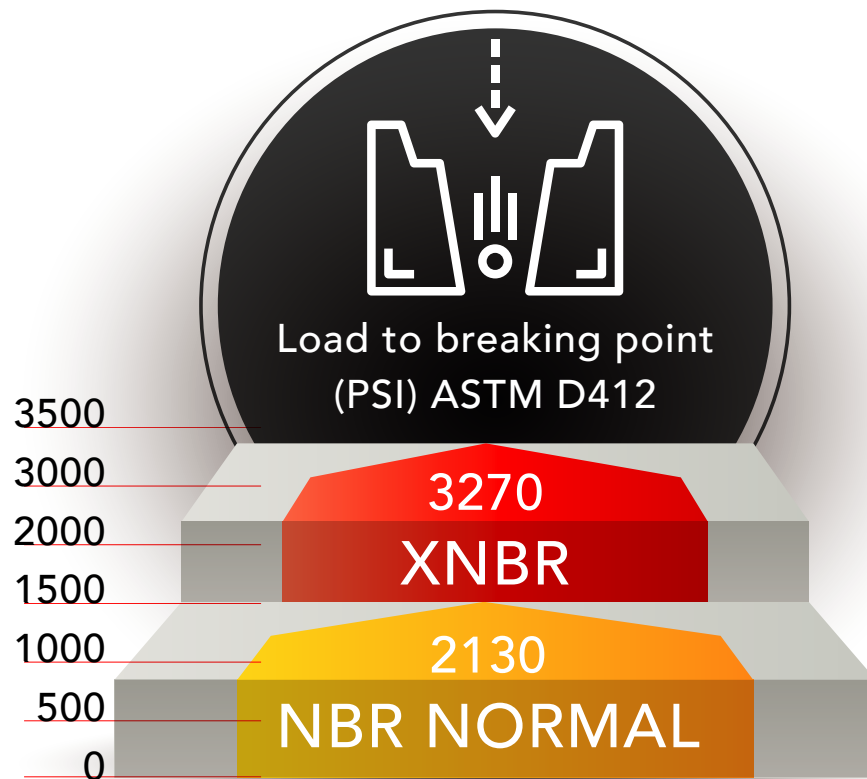

# ARI THE ORIGINAL FORK OIL SEALS **XNBR**

## IT ARIETE FORK OIL SEALS, gli specifici anelli di tenuta per forcelle

L'anello di tenuta paraolio per forcella prodotto dalla Ariete si differenzia da tutti gli altri disponibili sul mercato per l'alta qualità ed unicità del materiale utilizzato per la sua realizzazione: l'elastomero carbossilico **XNBR**. Questa miscela infatti possiede caratteristiche eccezionali di resistenza alla abrasione, alla temperatura ed agli olii con particolari additivi usati nelle moderne forcelle per moto e scooters. L'anello di tenuta per forcella lavorando in senso longitudinale sullo stelo è sottoposto ad una notevole azione abrasiva che unita al calore generato dallo scorrimento provoca un processo di deterioramento della parte in gomma che già è messa a dura prova dall'aggressione chimica degli olii con relativi additivi. La normale gomma nitrilica NBR, solitamente impiegata da tutti i produttori di anelli paraolio, è una scelta mediocre determinata da fattori di economicità.

Lo Staff Tecnico della Ariete, dopo approfonditi studi e sperimentazioni e supportato dall'esperienza maturata dall'Azienda in settanta anni di attività, ha adottato per questa linea di anelli paraolio l'elastomero carbossilico **XNBR** che rispetto al tipo normale NBR presenta le seguenti performances:

Le sofisticate tecnologie di produzione impiegate dall' Ariete permettono di ottenere prezzi altamente competitivi nonostante il costo dell'elastomero **XNBR** sia quasi il doppio del tipo normale permettendo al Cliente Ariete di avere un prodotto di altissima qualità che soddisfi le più esigenti aspettative ad un prezzo equo.

## UK ARIETE FORK OIL SEALS, custom-made for your fork

Ariete fork oil seals are different! The quality of their execution is matched by the unique nature of the material used: the carboxylated elastomer known as **XNBR**.

This compound offers unique characteristics of resistance to abrasion, to high temperatures, and to the complex lubricants with numerous additives, which are used in modern forks as fitted to motorcycles and scooters. The reciprocating action of the fork tube against the seal subjects it to a notable degree of abrasion, which is complicated by the heat generated as a result of hydraulic displacement within the fork, plus the friction of the components involved. This mechanical wear and tear leads to accelerated ageing of the rubber which is also obliged to deal with the chemical action of the various additives in the lubricant. Oil seals are normally made from a nitrile rubber, known as NBR. This is used because it is cheap, and plentiful, not because NBR is the best material for the job. Our technical staff have accumulated 70 years of experience in the rubber industry, and have spent many years looking for a better material for the manufacture of oil seals. In our view, the carboxylated elastomer known as **XNBR** has the following major advantages when compared with NBR:

Although the cost of **XNBR** is almost twice that of NBR, the sophisticated technology used to make our oil seals enables us to put them on the market at highly competitive prices. In this way, the Ariete Customer enjoys the benefits of a very high quality product, which satisfies the most demanding requirements, at a competitive price.

## FR ARIETE FORK OIL SEALS, les Joints Spy de fourche

Le Joint Spy de fourche produit par Ariete se différencie de tous les autres disponibles sur le marché par la haute qualité et le matériel unique utilisé pour sa réalisation: l'élastomère carboxylique **XNBR**. Ce mélange comporte des caractéristiques exceptionnelles de résistance à l'abrasion, à la température et aux huiles contenant des additifs particuliers utilisés dans les fourches modernes pour motos et scooters. Les joints spy de fourche en travaillant de façon longitudinale le tube sont soumis à une importante action abrasive qui, avec la chaleur, produite par le frottement provoque un processus de détérioration de la partie en caoutchouc qui est déjà mis à dure épreuve par l'agression chimique des huiles et ses additifs. Le caoutchouc nitrile NBR, habituellement employé par tous les fabricants de joints spy, est un choix médiocre déterminé par des facteurs économiques. Le Staff Technique de Ariete après des études approfondies et des expérimentations effectués grâce à l'expérience de la Société après soixante-dix ans d'activité, a adopté pour cette ligne de produits l'élastomère carboxylique **XNBR** qui par rapport au type normal NBR présente les performances suivantes:

Les technologies de production particulièrement sophistiquées employées par Ariete permettent d'obtenir des prix hautement compétitifs malgré que le coût de l'élastomère **XNBR** soit presque le double du type normal permettant au Client Ariete d'avoir un produit de très haute qualité qui satisfait les demandes les plus exigeantes à un prix abordable.

## ES ARIETE FORK OIL SEALS, el retén específico para horquilla

El retén de horquilla producido por Ariete se diferencia de otros productos existentes por la alta calidad y unicidad del material utilizado para su fabricación: el elastómero carboxilico **XNBR**. Esta mezcla posee en efecto características excepcionales de resistencia a la abrasión, a la temperatura y a los aceites que con aditivos muy específicos se utilizan en las horquillas de motocicleta y scooter. El retén para horquilla, al trabajar en sentido longitudinal a la barra está expuesto a una notable acción abrasiva que unida al calor provocado por la fricción generan un proceso de deterioro de la goma. Es importante entender que esta ya ha sido puesta a una dura prueba debido a la agresión de los aditivos que tiene los aceite para horquilla. Los compuestos de gomas nitrílicas NBR, normalmente empleadas en la producción de todos los retenes de horquilla es una mediocre elección determinada por factores exclusivamente económicos. Setenta años de experiencia, sobre todo en el exigente mundo industrial, han determinado que el equipo dirigente de Ariete determinara que la producción de estos productos ha de tener de forma exclusiva el elastómero de carbonosilicio **XNBR** que respecto a los tipos normales NBR tiene las siguientes ventajas:

Las sofisticadas técnicas de producción empleadas en Ariete permiten obtener unos precios altamente competitivos a pesar de que el costo del compuesto **XNBR** es prácticamente el doble del tipo normal. Para nosotros es importante explicar que el Cliente Ariete obtiene unos productos de altísima calidad que satisfarán las mas exigentes expectativas.

# ARI THE ORIGINAL FORK OIL SEALS

**IT** ARISIL lo speciale grasso lubrificante per anelli di tenuta. L'anello di tenuta paraolio per forcella ARI è prodotto con una miscela di gomma specifica per resistere agli olii, con relativi additivi, utilizzati nelle sospensioni. Questa miscela è completamente diversa da quella usata normalmente per gli anelli paraolio per alberi rotanti, in quanto deve resistere in modo diverso all'aggressione chimica causata dagli olii ed al lavoro meccanico in senso longitudinale tipico della forcella. I nostri anelli di tenuta paraolio ARI sono inoltre concepiti con una struttura di labbri di tenuta particolari con diverse sezioni per meglio resistere e al tempo stesso ridurre il più possibile l'attrito dello stelo all'interno del paraolio. Nel corso degli anni si è evidenziato il ruolo indispensabile di un lubrificante separatore tra lo stelo e l'anello in gomma che riduca il più possibile l'attrito senza compromettere la tenuta della guarnizione. Per risolvere questo problema abbiamo testato diversi grassi e la scelta è caduta su uno speciale grasso siliconico, prodotto negli USA studiato appositamente per le applicazioni gomma-metallo degli organi meccanici dei veicoli spaziali della NASA. Il vantaggio di questo grasso particolare che abbiamo denominato ARISIL sta nel fatto di prolungare la vita del paraolio preservando l'integrità delle caratteristiche fondamentali di resistenza chimica ed elastica. Per questo motivo in tutte le nostre confezioni di ARI FORK OIL SEALS includiamo una bustina monodose di ARISIL che serve per il corretto montaggio dei 2 paraolio.

**UK** ARISIL special oil seal lubricant. ARI fork oil seals are made from a rubber compound specifically developed to work with the lubricants used in front forks, with all their various additives. This compound is completely different from that normally used for rotating shaft seals, since the physical environment inside a fork with its reciprocating movement, and the specialist lubricants, are completely different. We have designed ARI oil seals with a variety of lip profiles to make them longer lasting, while reducing to a minimum the friction effect against the moving shaft. Over the years, we have discovered the key role of a separating lubricant between the fork tube and the rubber of the oil seal to reduce to a minimum the surface friction, without affecting the function of the oil seal. After exhaustive testing, we have chosen a lubricant which is produced in the USA, and devised specifically as a rubber/metal lubricant for mechanical components used in the NASA space program. The advantage of this special grease, which we call ARISIL, is that it extends the life of the oil seal, and helps it retain its vital characteristics of flexibility and chemical resistance. For this reason, every set of ARI FORK OIL SEALS contains a single dose sachet of ARISIL, sufficient to lubricate the two oil seals supplied.

**FR** ARISIL la graisse speciale lubrificante pour joints spy. Le joint spy de fourche ARI est produit avec un mélange de caoutchouc spécifique pour résister aux huiles, et ses additifs utilisés dans les fourches. Ce mélange est totalement différent de celui qui est normalement utilisé pour les joints spy de vilebrequin. En effet il doit résister à l'agression chimique causée par les huiles et au travail mécanique dans le sens longitudinale typique du fonctionnement d'une fourche. Nos joints spy de fourche ARI sont conçus avec une géométrie de lèvres particulièrement étudiée avec différentes sections pour mieux résister à l'abrasion et en même temps réduire au maximum le frottement du tube de fourche à l'intérieur du joint spy. Au cours des années nous avons mis en évidence le rôle indispensable de la forme des lèvres ainsi que leur usinage afin de réduire au maximum le frottement sans pour cela compromettre l'étanchéité de joint. Pour résoudre ce problème, nous avons testé plusieurs graisses et notre choix s'est arrêté sur une graisse spéciale siliconique, produite aux USA et étudiée pour les applications caoutchouc-métal des organes mécaniques des véhicules spatiaux de la NASA. L'avantage de cette graisse particulière que nous avons nommée ARISIL, consiste à prolonger la durée de vie du joint spy tout en préservant l'intégrité des caractéristiques fondamentales de résistance chimique et élastique. C'est pour cette raison que dans toutes nos boîtes de ARI FORK OIL SEALS nous joignons une pochette monodose de ARISIL qui sert pour le montage correct des 2 joints spy.

**ES** ARISIL la grasa especial para retenes. Los retenes de horquilla ARI se han fabricado con un tipo de goma resistente a los aditivos que llevan los aceites de suspensión. Esta mezcla es completamente diferente de la que pueda utilizarse para los retenes de cigueñal, ya que debe resistir de una forma diferente la agresión química causada por el aceite, así como el trabajo mecánico en el sentido longitudinal propio de la suspensión. Nuestros retenes ARI se han proyectado, además, con estructuras en el borde del labio diferentes para mejorar la resistencia y al mismo tiempo reducir el máximo posible la fricción de la barra en el interior del reten. La experiencia ha demostrado que es necesario un lubricante separador entre la barra y el reten, su misión es reducir la fricción sin deteriorar la estanqueidad de la junta. Para resolver este problema probamos diversos componentes grasos, el escogido fue una grasa silicona, producida en los U.S.A. y especialmente estudiada como aplicación para goma - metal de los órganos mecánicos de los vehículos espaciales de la N.A.S.A. Las ventajas de esta grasa, que hemos denominado ARISIL, reside en el factor que permite alargar la vida del retén preservando la integridad de las características fundamentales de resistencia química y elástica. Por este motivo hemos incluido en todos nuestros kits de reparación ARI FORK OIL SEALS, una bolsa de ARISIL que sirve para montar de forma correcta los dos retenes.

## TYPICAL CHARACTERISTICS

Product type:	<b>GREASE</b>
Colour:	<b>WHITE</b>
Composition:	<b>SILICONE LUBRICANT WITH ADDITIVES</b>
Temperature range	<b>-65° degrees c =&gt; +175° degrees c</b>
Coefficient of friction	<b>0.003 - load 6.3 n at 10 mm per second 24h</b>
USA military specification	<b>G-4343 C</b>



**10945** 1 gr. - 0,03527 ounces



**12950** 100 gr. - 3,527 ounces



# ARI THE ORIGINAL FORK OIL SEALS

**IT** Questo attrezzo per montare correttamente i paraolio su forcelle tradizionali e rovesciate (upside down) è disponibile per paraolio da 35 a 51 mm di diametro interno. Ricavato dal pieno è in acciaio con trattamento galvanico anticorrosione ed ha una superficie esterna lavorata per una presa sicura. Il peso è tra gli 800 ed i 1000 grammi a seconda delle misure. Viene venduto singolarmente.

**UK** The Split fork seal driver is a tool used for changing the fork seals on conventional and upside down forks. Available for fork seals in 35 mm thru 51 mm configurations. Manufactured from plated carbon steel, featuring split design and weighted body. Weight range from 800 to 1.000 gr. Sold individually.

**FR** Cet outil pour monter correctement les joint-spy sur les fourches traditionnelles et inversées (upside down) est disponible pour joint-spy de 35 à 51 mm de diamètre intérieur. Creusé dans la masse il est en acier galvanisé anti-corrosion et a une surface extérieure travaillée pour permettre une prise en toute sécurité. Son poids est compris entre 800 et 1000 grammes selon les mesures. Il est vendu séparément.

**ES** Este útil para el montaje correcto de los retenes en horquillas tradicionales e invertidas (upside down) está disponible para retenes de 35 a 51 mm de diámetro interno. Realizado a partir de un bloque de acero mecanizado, con un tratamiento anticorrosión, posee una superficie externa que permite un perfecto agarre. El peso está comprendido entre 800 y 1000 grs. Se vende por unidades.

CODE	TUBE Ø mm		CODE	TUBE Ø mm	
12930/35	Ø 35	€ 50, <sup>20</sup> + IVA/VAT	12930/44	Ø 44	€ 54, <sup>20</sup> + IVA/VAT
12930/36	Ø 36	€ 50, <sup>20</sup> + IVA/VAT	12930/45	Ø 45	€ 54, <sup>20</sup> + IVA/VAT
12930/37	Ø 37	€ 50, <sup>20</sup> + IVA/VAT	12930/46	Ø 46	€ 54, <sup>20</sup> + IVA/VAT
12930/38	Ø 38	€ 50, <sup>20</sup> + IVA/VAT	12930/47	Ø 47	€ 57, <sup>90</sup> + IVA/VAT
12930/39	Ø 39	€ 50, <sup>20</sup> + IVA/VAT	12930/48	Ø 48	€ 57, <sup>90</sup> + IVA/VAT
12930/40	Ø 40	€ 50, <sup>20</sup> + IVA/VAT	12930/49	Ø 49	€ 57, <sup>90</sup> + IVA/VAT
12930/41	Ø 41	€ 50, <sup>20</sup> + IVA/VAT	12930/50	Ø 50	€ 57, <sup>90</sup> + IVA/VAT
12930/42	Ø 42	€ 50, <sup>20</sup> + IVA/VAT	12930/51	Ø 51	€ 57, <sup>90</sup> + IVA/VAT
12930/43	Ø 43	€ 54, <sup>20</sup> + IVA/VAT			



Sherco Factory Racing - Photo Jean-Marie Pouget



## ARI THE ORIGINAL FORK OIL SEALS

## LIST BY SIZE

SIZE	TYPE	CODE	SIZE	TYPE	CODE	SIZE	TYPE	CODE
24 X 32 X 7/7,5	KCY	ARI.110	33 X 45 X 8/10,5	TCL	ARI.071	37,8 X 48 X 6/6,5	TCY	ARI.017
25,7 X 37 X 10,5	TC4	ARI.075	33 X 45 X 8/10,5	DC4Y	ARI.100	38 X 48 X 10	TC4	ARI.094
26 X 35,5/37,7 X 6/13,5	Y	ARI.076	33 X 45,5/49,7 X 4,5/13,8	Y	ARI.121	38 X 49,1/54 X 6/15,5	Y	ARI.092
26 X 37 X 10,5	TC4	ARI.052	33 X 46 X 10,5	TC4	ARI.004	38 X 50 X 10,5	TC4	ARI.021
26 X 37,5/43 X 14	XICY	ARI.175	33 X 46 X 11	DCY	ARI.073	38 X 50 X 11	TC4	ARI.062
27 X 39 X 10,5	TC4	ARI.009	33 X 46 X 11	DC4	ARI.096	38 X 50 X 7/8	TCL	ARI.029
28 X 38 X 7	SC	ARI.010	33 X 46,5/53 X 5,8/15	XICY	ARI.140	38 X 50 X 8/9,5	TCY	ARI.032
28 X 40 X 8	TC4	ARI.111	33,34 X 49,21 X 12,7/17,5	TCY	ARI.038	38 X 52 X 11	DCY	ARI.059
28,5 X 40 X 7/11	TC3Y	ARI.160	34 X 46 X 10,5	TB4	ARI.002	38,5 X 48 X 7/8,7	TBCL	ARI.084
29 X 41 X 11	DCY	ARI.055	35 X 46 X 11	DC4Y-2	ARI.149	39 X 51 X 10,5/12	TCL	ARI.070
29,8 X 40 X 7	TC4	ARI.098	35 X 46 X 8/11	DC4Y-1	ARI.171	39 X 51 X 8/10,5	TCL	ARI.058
30 X 39/43 X 12	DG5Y	ARI.112	35 X 46,8/51,3 X 5/12,5	SG5Y	ARI.148	39 X 51 X 8/10,5	DC4Y-1	ARI.156
30 X 40 X 7/8	KCY	ARI.080	35 X 47 X 10	DCY	ARI.040	39 X 51 X 8/9,5	TCL+Y	ARI.068
30 X 40 X 7/9	TCY	ARI.020	35 X 47 X 10/10,5	TCL	ARI.022	+ 39 X 51,1/55,6 X 4,7/11,5		
30 X 40 X 8/12	TC6YI	ARI.113	35 X 47 X 7,5/10	DCY	ARI.066	39 X 51,5 X 4,8/14	XICY	ARI.154
30 X 40 X 8/9	TCY	ARI.079	35 X 47 X 7/9	TCY	ARI.012	39 X 52 X 11	DCY	ARI.037
30 X 40,5 X 10,5/12	TCL	ARI.048	35 X 47 X 9,5/10,5	TC4Y	ARI.051	40 X 49,5 X 7/9,5	DC4Y	ARI.035
30 X 42 X 10,5	TB4	ARI.016	35 X 48 X 10,5	TC4	ARI.024	40 X 52 X 10	DC4	ARI.157
30 X 42 X 8/11	DCY1	ARI.142	35 X 48 X 11	DCY	ARI.003T	40 X 52 X 10/10,5	TCL	ARI.023
31 X 43 X 10,5	DCY	ARI.005	35 X 48 X 13/14,5	TCL	ARI.003R	40 X 52 X 8/10,5	TCL	ARI.063
31 X 43,5 X 5,6/14	XICY	ARI.173	35 X 48 X 8/10,5	TCL	ARI.061	40 X 52 X 8/9,5	TCY	ARI.033
31,5 X 45 X 7,1	TG4	ARI.161	35 X 48 X 8/9,5	TCY	ARI.049	40 X 52,5 X 4,6/14	Y	ARI.124
31,7 X 42 X 7/9	TCL	ARI.078	35 X 48,2 X 8/10,2	DC4Y	ARI.141	40 X 56,5 X 14	Y-2	ARI.166
31,74 X 42 X 9	TC4	ARI.103	35 X 48,5/53 X 5,8/15	XICY	ARI.130	41 X 51 X 6	SC4	ARI.045
31,75 X 42,8/48 X 7,6/11,6	Y+TCL	ARI.077	36 X 46 X 7/9	TCY	ARI.043	41 X 52,2 X 11	DCY1	ARI.143
+ 31,7 X 42 X 7/9			36 X 48 X 10,5	TC4	ARI.001	41 X 52,5 X 4,6/14	Y-2	ARI.150
31,8 X 42 X 7	TC4	ARI.133	36 X 48 X 11	TC4-1	ARI.114	41 X 53 X 10,5	TC4	ARI.041
32 X 42 X 7	SC	ARI.013	36 X 48 X 11/12,5	TCL	ARI.025	41 X 53 X 11	TC4	ARI.132
32 X 42 X 7/9	TCY	ARI.011	36 X 48 X 8/9,5	TCL	ARI.046	41 X 53 X 8/10,5	TCL	ARI.057
32 X 42 X 8/9	TCY	ARI.014	36 X 48,5/52,5 X 6/14	Y	ARI.115	41 X 53 X 8/10,5	DC	ARI.102
32 X 43 X 12,5	TB4	ARI.031	37 X 47 X 11	DCY1	ARI.169	41 X 53 X 8/9,5 (EX ARI.064)	TCY	ARI.056
32 X 44 X 10,5	TC4	ARI.060	37 X 47,4 X 4,6/14	Y-1	ARI.170	41 X 53,5/58 X 4,8/14	XICY	ARI.138
32 X 45 X 7	TC	ARI.122	37 X 49 X 8/10	DCY	ARI.050	41 X 53,7 X 5/10	YC	ARI.128
32 X 45 X 9/11	TCL	ARI.074	37 X 49/49,4 X 8/9,5	TCL	ARI.027	41 X 54 X 11	DCY	ARI.047
33 X 43 X 6,5/7,5	TCL	ARI.015	37 X 50 X 11	DCY	ARI.044	41 X 54 X 5,6/12,7	Y-24	ARI.151
33 X 45 X 10	TC4	ARI.135	37 X 50,5 X 5,6/12,8	Y-2	ARI.162	41 X 54,3 X 5,8/15	Y	ARI.153
33 X 45 X 11	TC4	ARI.101	37 X 50,5 X 5,8/15	Y-24A	ARI.174	41,3 X 54 X 13/14	TACY-6	ARI.089

SIZE	TYPE	CODE	SIZE	TYPE	CODE
41,7 X 55 X 10/10,5	TCL	ARI.028	48 X 58,2 X 8,5/10,5	DC4Y	ARI.117
41,7 X 55 X 7,5/10	DCY	ARI.083	48 X 58,4 X 5,8/13	Y-2	ARI.176
41,7 X 55 X 8/10,5	TC4Y	ARI.034	48 X 58,5/62 X 6/11,5	Y-1	ARI.126
42 X 55,5 X 6/11	VCY	ARI.164	48 X 60 X 9,5/10,5	DC4Y-1	ARI.167
43 X 52,7 X 9,5/10,5	TCY	ARI.107	48 X 60,5/64,7 X 5/14	Y	ARI.168
43 X 52,9 X 9,2	DC4Y-1	ARI.158	48 X 61 X 11	TC4	ARI.134
43 X 53,4 X 6/13	Y-1	ARI.159	48 X 61 X 6/15	Y-2	ARI.165
43 X 54 X 11	TC4	ARI.053	49 X 60 X 10	TC4	ARI.104
43 X 54 X 11	DCY	ARI.118	49 X 60,5 X 6/10,5	Y-1	ARI.163
43 X 54 X 9,5/10,5	TCL	ARI.090	50 X 59,6 X 7/10,5	DC4Y	ARI.085
43 X 54,2/59,8 X 6/11	Y-11	ARI.129	50 X 60/63 X 7/13	Y	ARI.086
43 X 54,3 X 6/13	Y-1	ARI.152	50 X 62 X 9,5/11,5	DC4Y	ARI.125
43 X 54,3 X 6/15,4	Y	ARI.155	50 X 63 X 11	TGY	ARI.093
43 X 54,4 X 4,6/14	Y	ARI.119	50 X 63 X 11	DCY	ARI.136
43 X 55 X 10,5/12	TCL	ARI.036	50 X 63,4 X 4,6/14	SG5Y	ARI.137
43 X 55 X 11	TC4	ARI.123			
43 X 55 X 11/14	TCL	ARI.127			
43 X 55 X 9,5/10,5	TCL	ARI.072			
43 X 55 X 9,5/10,5	DC4Y	ARI.109			
43 X 55,7/60 X 5/14	XICY	ARI.144			
45 X 57 X 11	DCY	ARI.067			
45 X 57,3/62 X 6/13	SG5Y	ARI.091			
45 X 58 X 11	DCY	ARI.120			
45 X 58 X 8,5/11	DG4Y	ARI.082			
45 X 58,3/62,3 X 4,5/11	Y-9	ARI.081			
46 X 58 X 10,5	DC4	ARI.108			
46 X 58 X 8,5/11,5	DC4Y-1	ARI.146			
46 X 58,1 X 9,5/11,5	DCY	ARI.087			
46 X 58,5 X 4,8/14	XICY	ARI.172			
46 X 58,5 X 5/10	YC	ARI.131			
46 X 58,5/62,3 X 5,8/13,2	Y-9	ARI.147			
46 X 58,5/62,5 X 5/11,5	Y	ARI.088			
47 X 58 X 10	TC4	ARI.105			
47 X 58,5/62 X 6/10,3	SG5	ARI.106			
48 X 57,7 X 9,5/10,3	TCL1	ARI.116			
48 X 57,91 X 9,5/11,5	DC4Y	ARI.139			
48 X 58 X 9/9,8	TCL1	ARI.145			





# MX APPLICATION LIST X No Bike - Not Available

BIKE	2019	2018	2017	2016	2015	2014	2013	2012	2011	2010	2009	2008	2007	2006	2005	2004	2003	2002	2001	2000	1999
<b>Honda CR</b>																					
80-85	x	x	x	x	x	x	x	x	x	x	x	ARI.044	ARI.044	ARI.044	ARI.044	ARI.044	ARI.044	ARI.044	ARI.044	ARI.044	ARI.044
CAP	x	x	x	x	x	x	x	x	x	x	x	ARI.162	ARI.162	ARI.162	ARI.162	ARI.162	ARI.162	ARI.162	ARI.162	ARI.162	ARI.162
125	x	x	x	x	x	x	x	x	x	x	x	x	ARI.108	ARI.108	ARI.108	ARI.087	ARI.087	ARI.087	ARI.087	ARI.087	ARI.087
CAP	x	x	x	x	x	x	x	x	x	x	x	x	ARI.131	ARI.131	ARI.131	ARI.088	ARI.088	ARI.088	ARI.088	ARI.088	ARI.088
250	x	x	x	x	x	x	x	x	x	x	x	x	ARI.105	ARI.105	ARI.105	ARI.105	ARI.105	ARI.105	ARI.105	ARI.105	ARI.105
CAP	x	x	x	x	x	x	x	x	x	x	x	x	ARI.106	ARI.106	ARI.106	ARI.106	ARI.106	ARI.106	ARI.106	ARI.106	ARI.106
250/F	ARI.104	ARI.104	ARI.104	ARI.104	ARI.104	ARI.117	ARI.117	ARI.117	ARI.117	ARI.117	ARI.105	ARI.105	ARI.105	ARI.105	ARI.105	ARI.105	x	x	x	x	x
CAP	ARI.163	ARI.163	ARI.163	ARI.163	ARI.163	ARI.126	ARI.126	ARI.126	ARI.126	ARI.126	ARI.106	ARI.106	ARI.106	ARI.106	ARI.106	ARI.106	x	x	x	x	x
450	x	x	x	x	x	x	x	X	X	X	X	X	x	x	x	x	x	x	ARI.087	ARI.087	ARI.087
CAP	x	x	x	x	x	x	x	X	X	X	X	X	x	x	x	x	x	x	ARI.088	ARI.088	ARI.088
450/F	ARI.104	ARI.104	ARI.104	ARI.117	ARI.117	ARI.117	ARI.117	ARI.145	ARI.145	ARI.145	ARI.117	ARI.105	ARI.105	ARI.105	ARI.105	ARI.105	ARI.105	ARI.105	x	x	x
CAP	ARI.163	ARI.163	ARI.163	ARI.126	ARI.126	ARI.126	ARI.126	ARI.126	ARI.126	ARI.126	ARI.126	ARI.106	ARI.106	ARI.106	ARI.106	ARI.106	ARI.106	ARI.106	x	x	x
500	x	x	x	x	x	x	x	x	x	x	x	x	x	x	x	ARI.105	ARI.105	ARI.105	ARI.087	ARI.087	ARI.087
CAP	x	x	x	x	x	x	x	x	x	x	x	x	x	x	x	ARI.106	ARI.106	ARI.106	ARI.088	ARI.088	ARI.088
<b>Yamaha YZ-WR</b>																					
85	ARI.046	ARI.046	ARI.046	ARI.046	ARI.046	ARI.046	ARI.046	ARI.046	ARI.046	ARI.046	ARI.046	ARI.046	ARI.046	ARI.046	ARI.046	ARI.046	ARI.046	ARI.046	x	x	x
CAP	ARI.115	ARI.115	ARI.115	ARI.115	ARI.115	ARI.115	ARI.115	ARI.115	ARI.115	ARI.115	ARI.115	ARI.115	ARI.115	ARI.115	ARI.115	ARI.115	ARI.115	ARI.115	x	x	x
125 LC	ARI.145	ARI.145	ARI.145	ARI.145	ARI.145	ARI.145	ARI.117	ARI.117	ARI.117	ARI.117	ARI.117	ARI.117	ARI.117	ARI.117	ARI.117	ARI.117	ARI.087	ARI.087	ARI.087	ARI.087	ARI.087
CAP	ARI.126	ARI.126	ARI.126	ARI.126	ARI.126	ARI.126	ARI.126	ARI.126	ARI.126	ARI.126	ARI.126	ARI.126	ARI.126	ARI.126	ARI.126	ARI.126	ARI.088	ARI.088	ARI.088	ARI.088	ARI.088
250 LC	ARI.145	ARI.145	ARI.145	ARI.145	ARI.145	ARI.117	ARI.117	ARI.117	ARI.117	ARI.117	ARI.117	ARI.117	ARI.117	ARI.117	ARI.117	ARI.117	ARI.087	ARI.087	ARI.087	ARI.087	ARI.087
CAP	ARI.126	ARI.126	ARI.126	ARI.126	ARI.126	ARI.126	ARI.126	ARI.126	ARI.126	ARI.126	ARI.126	ARI.126	ARI.126	ARI.126	ARI.126	ARI.126	ARI.088	ARI.088	ARI.088	ARI.088	ARI.088
250/F	ARI.145	ARI.145	ARI.145	ARI.145	ARI.145	ARI.145	ARI.145	ARI.145	ARI.145	ARI.145	ARI.117	ARI.117	ARI.117	ARI.117	ARI.117	ARI.117	x	x	x	x	x
CAP	ARI.126	ARI.126	ARI.126	ARI.126	ARI.126	ARI.126	ARI.126	ARI.126	ARI.126	ARI.126	ARI.126	ARI.126	ARI.126	ARI.126	ARI.126	ARI.126	x	x	x	x	x
400	x	x	x	x	x	x	x	x	x	x	x	x	x	x	x	x	ARI.087	ARI.087	ARI.087	ARI.087	ARI.087
CAP	x	x	x	x	x	x	x	x	x	x	x	x	x	x	x	x	ARI.088	ARI.088	ARI.088	ARI.088	ARI.088
426	x	x	x	x	x	x	x	x	x	x	x	x	x	x	x	x	ARI.087	ARI.087	ARI.087	ARI.087	ARI.087
CAP	x	x	x	x	x	x	x	x	x	x	x	x	x	x	x	x	ARI.088	ARI.088	ARI.088	ARI.088	ARI.088
450/F	ARI.145	ARI.145	ARI.145	ARI.145	ARI.145	ARI.145	ARI.145	ARI.145	ARI.145	ARI.145	ARI.117	ARI.117	ARI.117	ARI.117	ARI.117	ARI.117	x	x	x	x	x
CAP	ARI.126	ARI.126	ARI.126	ARI.126	ARI.126	ARI.126	ARI.126	ARI.126	ARI.126	ARI.126	ARI.126	ARI.126	ARI.126	ARI.126	ARI.126	ARI.126	x	x	x	x	x
<b>Kawasaki KX</b>																					
60	x	x	x	x	x	x	x	x	x	x	x	x	x	x	x	x	ARI.016	ARI.016	ARI.016	ARI.016	ARI.016
CAP	x	x	x	x	x	x	x	x	x	x	x	x	x	x	x	x	-	-	-	-	-
65	ARI.096	ARI.096	ARI.096	ARI.096	ARI.096	ARI.096	ARI.096	ARI.096	ARI.096	ARI.096	ARI.096	ARI.096	ARI.096	ARI.096	ARI.096	ARI.096	ARI.096	ARI.096	ARI.096	ARI.096	x
CAP	-	-	-	-	-	-	-	-	-	-	-	-	-	-	-	-	-	-	-	-	x
80/85	ARI.046	ARI.046	ARI.046	ARI.046	ARI.046	ARI.046	ARI.046	ARI.046	ARI.046	ARI.046	ARI.046	ARI.046	ARI.046	ARI.046	ARI.046	ARI.046	ARI.046	ARI.046	ARI.046	ARI.046	ARI.046
CAP	ARI.115	ARI.115	ARI.115	ARI.115	ARI.115	ARI.115	ARI.115	ARI.115	ARI.115	ARI.115	ARI.115	ARI.115	ARI.115	ARI.115	ARI.115	ARI.115	ARI.115	ARI.115	ARI.115	ARI.115	ARI.115
100	ARI.046	ARI.046	ARI.046	ARI.046	ARI.046	ARI.046	ARI.046	ARI.046	ARI.046	ARI.046	ARI.046	ARI.046	ARI.046	ARI.046	ARI.046	ARI.046	ARI.046	ARI.046	ARI.046	ARI.046	ARI.046
CAP	ARI.115	ARI.115	ARI.115	ARI.115	ARI.115	ARI.115	ARI.115	ARI.115	ARI.115	ARI.115	ARI.115	ARI.115	ARI.115	ARI.115	ARI.115	ARI.115	ARI.115	ARI.115	ARI.115	ARI.115	ARI.115

# MX APPLICATION LIST X No Bike - Not Available

BIKE	2019	2018	2017	2016	2015	2014	2013	2012	2011	2010	2009	2008	2007	2006	2005	2004	2003	2002	2001	2000	1999	
<b>Kawasaki KX</b>																						
125/250	x	x	x	x	x	x	x	x	x	x	x	ARI.117	ARI.117	ARI.117	ARI.117	ARI.117	ARI.117	ARI.117	ARI.087	ARI.087	ARI.087	
CAP	x	x	x	x	x	x	x	x	x	x	x	ARI.126	ARI.126	ARI.126	ARI.126	ARI.126	ARI.126	ARI.126	ARI.088	ARI.088	ARI.088	
250/F	ARI.117	ARI.117	ARI.117	ARI.117	ARI.117	ARI.117	ARI.117	ARI.105	ARI.105	ARI.105	ARI.105	ARI.105	ARI.105	ARI.105	ARI.117	x	x	x	x	x	x	
CAP	ARI.126	ARI.126	ARI.126	ARI.126	ARI.126	ARI.126	ARI.126	ARI.106	ARI.106	ARI.106	ARI.106	ARI.106	ARI.106	ARI.106	ARI.126	x	x	x	x	x	x	
450/F	ARI.104	ARI.104	ARI.104	ARI.104	ARI.104	ARI.145	ARI.145	ARI.145	ARI.145	ARI.145	ARI.117	ARI.117	ARI.117	ARI.117	x	x	x	x	x	x	x	
CAP	ARI.163	ARI.163	ARI.163	ARI.163	ARI.163	ARI.126	ARI.126	ARI.126	ARI.126	ARI.126	ARI.126	ARI.126	ARI.126	ARI.126	x	x	x	x	x	x	x	
<b>Suzuki RM</b>																						
80/85	ARI.044	ARI.044	ARI.044	ARI.044	ARI.044	ARI.044	ARI.044	ARI.044	ARI.044	ARI.044	ARI.044	ARI.044	ARI.044	ARI.044	ARI.044	ARI.044	ARI.044	ARI.044	ARI.044	ARI.044	x	
CAP	ARI.162	ARI.162	ARI.162	ARI.162	ARI.162	ARI.162	ARI.162	ARI.162	ARI.162	ARI.162	ARI.162	ARI.162	ARI.162	ARI.162	ARI.162	ARI.162	ARI.162	ARI.162	ARI.162	ARI.162	ARI.162	x
125	x	x	x	x	x	x	x	ARI.105	ARI.105	ARI.105	ARI.105	ARI.105	ARI.105	ARI.105	ARI.105	ARI.105	ARI.105	ARI.105	ARI.105	ARI.105	ARI.104	ARI.104
CAP	x	x	x	x	x	x	x	ARI.106	ARI.106	ARI.106	ARI.106	ARI.106	ARI.106	ARI.106	ARI.106	ARI.106	ARI.106	ARI.106	ARI.106	ARI.106	ARI.163	ARI.163
250	x	x	x	x	x	x	x	x	x	x	ARI.105	ARI.105	ARI.105	ARI.105	ARI.105	ARI.105	ARI.105	ARI.105	ARI.105	ARI.105	ARI.104	ARI.104
CAP	x	x	x	x	x	x	x	x	x	x	ARI.106	ARI.106	ARI.106	ARI.106	ARI.106	ARI.106	ARI.106	ARI.106	ARI.106	ARI.106	ARI.163	ARI.163
250/Z	ARI.117	ARI.117	ARI.117	ARI.117	ARI.117	ARI.117	ARI.117	ARI.105	ARI.105	ARI.105	ARI.105	ARI.105	ARI.105	ARI.117	ARI.105	ARI.105	ARI.105	x	x	x	x	
CAP	ARI.126	ARI.126	ARI.126	ARI.126	ARI.126	ARI.126	ARI.126	ARI.106	ARI.106	ARI.106	ARI.106	ARI.106	ARI.106	ARI.126	ARI.106	ARI.106	ARI.106	x	x	x	x	
450/Z	ARI.104	ARI.104	ARI.104	ARI.104	ARI.104	ARI.117	ARI.117	ARI.105	ARI.105	ARI.105	ARI.105	ARI.105	ARI.105	ARI.105	x	x	x	x	x	x	x	
CAP	ARI.163	ARI.163	ARI.163	ARI.163	ARI.163	ARI.126	ARI.126	ARI.106	ARI.106	ARI.106	ARI.106	ARI.106	ARI.106	ARI.106	x	x	x	x	x	x	x	
<b>Ktm SX</b>																						
125	ARI.178	ARI.139	ARI.139	ARI.139	ARI.139	ARI.139	ARI.139	ARI.139	ARI.139	ARI.139	ARI.116	ARI.116	ARI.107	ARI.116	ARI.116	ARI.116	ARI.116	ARI.116	ARI.116	ARI.116	ARI.107	ARI.082
CAP	ARI.176	ARI.176	ARI.176	ARI.126	ARI.126	ARI.126	ARI.126	ARI.126	ARI.126	ARI.126	ARI.126	ARI.126	-	ARI.126	ARI.126	ARI.126	ARI.126	ARI.126	ARI.126	ARI.126	-	ARI.081
250	ARI.178	ARI.139	ARI.139	ARI.139	ARI.139	ARI.139	ARI.139	ARI.139	ARI.139	ARI.139	ARI.116	ARI.116	ARI.116	ARI.116	ARI.116	ARI.116	ARI.116	ARI.116	ARI.116	ARI.116	ARI.107	ARI.085
CAP	ARI.176	ARI.176	ARI.176	ARI.176	ARI.126	ARI.126	ARI.126	ARI.126	ARI.126	ARI.126	ARI.126	ARI.126	ARI.126	ARI.126	ARI.126	ARI.126	ARI.126	ARI.126	ARI.126	ARI.126	-	ARI.086
400/450/525	ARI.139	ARI.139	ARI.139	ARI.139	ARI.139	ARI.139	ARI.139	ARI.139	ARI.139	ARI.139	ARI.116	ARI.116	ARI.116	ARI.116	ARI.116	ARI.116	ARI.116	ARI.116	ARI.116	ARI.116	ARI.107	ARI.085
CAP	ARI.176	ARI.176	ARI.176	ARI.176	ARI.126	ARI.126	ARI.126	ARI.126	ARI.126	ARI.126	ARI.126	ARI.126	ARI.126	ARI.126	ARI.126	ARI.126	ARI.126	ARI.126	ARI.126	ARI.126	-	ARI.086
<b>Husqvarna</b>																						
<b>TC</b>																						
85	ARI.158	ARI.107	ARI.158	ARI.158	ARI.158	x	x	x	x	x	x	x	x	x	x	x	x	x	x	x	x	x
CAP	ARI.159	ARI.159	ARI.159	ARI.159	ARI.159	x	x	x	x	x	x	x	x	x	x	x	x	x	x	x	x	x
125	x	ARI.139	ARI.139	ARI.139	ARI.139	ARI.139	ARI.139	x	x	x	x	x	x	x	x	x	x	x	x	x	x	x
CAP	x	ARI.176	ARI.176	ARI.126	ARI.126	ARI.126	ARI.126	x	x	x	x	x	x	x	x	x	x	x	x	x	x	x
250	ARI.178	ARI.139	ARI.139	ARI.139	ARI.139	ARI.139	ARI.139	x	x	x	x	x	x	x	x	x	x	x	x	x	x	x
CAP	ARI.176	ARI.176	ARI.176	ARI.126	ARI.126	ARI.126	ARI.126	x	x	x	x	x	x	x	x	x	x	x	x	x	x	x
<b>Husqvarna</b>																						
<b>FC</b>																						
250	ARI.178	ARI.139	ARI.139	ARI.139	ARI.139	ARI.139	ARI.139	x	x	x	x	x	x	x	x	x	x	x	x	x	x	x
CAP	ARI.176	ARI.176	ARI.176	ARI.126	ARI.126	ARI.126	ARI.126	x	x	x	x	x	x	x	x	x	x	x	x	x	x	x
350	ARI.178	ARI.139	ARI.139	ARI.139	ARI.139	ARI.139	ARI.139	x	x	x	x	x	x	x	x	x	x	x	x	x	x	x
CAP	ARI.176	ARI.176	ARI.176	ARI.126	ARI.126	ARI.126	ARI.126	x	x	x	x	x	x	x	x	x	x	x	x	x	x	x
450	ARI.178	ARI.139	ARI.139	ARI.139	ARI.139	ARI.139	ARI.139	x	x	x	x	x	x	x	x	x	x	x	x	x	x	x
CAP	ARI.176	ARI.176	ARI.176	ARI.126	ARI.126	ARI.126	ARI.126	x	x	x	x	x	x	x	x	x	x	x	x	x	x	x



# TECHNICAL ACCESSORIES

MASTER CYLINDER SEAL KITS



IT Guarnizioni Pompa Freno  
 UK Brake Master-cylinders Seal Kit  
 FR Garnitures Pour Pompes Pour Freins  
 ES Juntas Bombas De Freno



IT Guarnizioni pinza freno  
 UK Brake calipers Seal kit  
 FR Garnitures pour fourches pour freins  
 ES Juntas de pinzas de freno



BRAKE CALIPERS SEAL KITS

IT **Ariete** presenta una nuova linea di guarnizioni per pinze e pompe freno, per moto e scooters, quale ricambio non originale delle più diffuse marche presenti nel mercato. Il materiale utilizzato per le guarnizioni è una speciale miscela a base di EPDM HP messa a punto da Ariete e particolarmente resistente ai liquidi per freno più comunemente usati, DOT3 e DOT4.

**Chiedere il catalogo specifico delle applicazioni ai vari modelli di moto e scooters.**

UK **Ariete** introduces a new line of seal kits to suit brake calipers and master-cylinders for motorcycles and scooters. These are after-market replacements which fit many of the most popular models on the market.

The material used for the seals is a special compound of EPDM HP, developed by Ariete and fully compatible with the most common brake fluids (DOT3 and DOT4).

**Ask for our special catalogue covering applications for different models of motorcycles and scooters.**

FR **Ariete** présente une nouvelle ligne de garnitures pour fourches et pompes pour freins pour motos et scooters, en tant que pièces détachées non originales des marques les plus répandues sur le marché. Le matériel utilisé pour les garnitures est un mélange spécial à base de EPDM HP mis à point par Ariete et particulièrement résistant aux liquides pour freins les plus communément utilisés, DOT3 et DOT4.

**Demandez le catalogue spécifique des applications des différents modèles de motos et scooters.**

ES **Ariete** presenta una nueva línea de juntas para pinzas y bombas de freno para motos y scooters, como pieza de repuesto no original de las más difundidas marcas del mundo. El material usado para las juntas es una especial mezcla de EPDM HP, estudiada por Ariete y particularmente resistente a los líquidos para los frenos más comúnmente usados, como DOT3 y DOT4.

**Pidan el catalogo específico de las aplicaciones a los varios modelos de motos y scooters.**

# DOT3 - DOT4 FLUID PIPE



12978/5

6x10 mm Pack. 5 mt. - 16' 5" black

IT Tubo raccordo tra la pompa freno ed il serbatoio del liquido freni DOT3 - DOT4

UK Low-pressure hydraulic pipe to fit between remote reservoir and master cylinder, suits DOT3 - DOT4 fluid





















FR Tube de raccordement du frein et réservoir liquide des freins DOT3 DOT4

ES Tubo enlace con bomba de freno y deposito para liquido DOT3 - DOT4























€ 98,<sup>50</sup> + IVA/VAT



# FUEL PIPES

Size	Code	Color	Pack	Use	Structure	Price
<b>1,5 x 4</b>	11949/10		10 mt. - 32' 10"	CARBURETTOR		€ 5, <sup>90</sup>
<b>1,5 x 4</b>	11949/10-T		10 mt. - 32' 10"	CARBURETTOR		€ 5, <sup>90</sup>
<b>2 x 5</b>	03998/10		10 mt. - 32' 10"	CARBURETTOR		€ 7, <sup>00</sup>
<b>2 x 5</b>	03998/10-T		10 mt. - 32' 10"	CARBURETTOR		€ 7, <sup>00</sup>
<b>3 x 6</b>	03999/10		10 mt. - 32' 10"	CARBURETTOR		€ 8, <sup>90</sup>
<b>3 x 6</b>	03999/10-T		10 mt. - 32' 10"	CARBURETTOR		€ 8, <sup>90</sup>
<b>4 x 7</b>	01925/10		10 mt. - 32' 10"			€ 10, <sup>90</sup>
<b>4 x 7</b>	01925/10-S		10 mt. - 32' 10"	UNLEADED FUEL	DOUBLE	€ 30, <sup>00</sup>
<b>4 x 7</b>	01925/10-V		10 mt. - 32' 10"			€ 10, <sup>90</sup>
<b>4 x 7</b>	01925-V		100 mt. - 328'			€ 90, <sup>90</sup>
<b>4,5 x 9</b>	01958/10		10 mt. - 32' 10"			€ 15, <sup>90</sup>
<b>4,5 x 9</b>	01958/10-V		10 mt. - 32' 10"			€ 15, <sup>90</sup>
<b>4,5 x 9</b>	01958-V		100 mt. - 328'			€ 139, <sup>50</sup>
<b>4,8 x 9</b>	11922/10-S		10 mt. - 32' 10"	UNLEADED FUEL	DOUBLE	€ 54, <sup>00</sup>
<b>5 x 8</b>	01922		100 mt. - 328'			€ 92, <sup>00</sup>
<b>5 x 8</b>	01922/10		10 mt. - 32' 10"			€ 12, <sup>90</sup>
<b>5 x 8</b>	01922/10-V		10 mt. - 32' 10"			€ 12, <sup>90</sup>
<b>5 x 8</b>	01922-V		100 mt. - 328'			€ 91, <sup>90</sup>
<b>5,5 x 10</b>	03904/10		10 mt. - 32' 10"			€ 17, <sup>90</sup>
<b>5,5 x 10</b>	03904/10-S		10 mt. - 32' 10"	UNLEADED FUEL	DOUBLE	€ 59, <sup>50</sup>

# FUEL PIPES

Size	Code	Color	Pack	Use	Structure	Price
<b>5,5 x 10</b>	03904/10-V		10 mt. - 32' 10"			€ 17, <sup>90</sup>
<b>6 x 9</b>	01958/A		100 mt. - 328'			€ 102, <sup>50</sup>
<b>6 x 9</b>	01958/A/10		10 mt. - 32' 10"			€ 14, <sup>90</sup>
<b>6 x 9</b>	01958/A10G		10 mt. - 32' 10"	UNLEADED FUEL	MONO	€ 17, <sup>90</sup>
<b>6 x 9</b>	01958/A10S		10 mt. - 32' 10"	UNLEADED FUEL	DOUBLE	€ 36, <sup>00</sup>
<b>6 x 9</b>	01958/A10V		10 mt. - 32' 10"			€ 14, <sup>90</sup>
<b>6 x 9</b>	01958/A-V		100 mt. - 328'			€ 102, <sup>50</sup>
<b>6 x 9</b>	09970/5		5 mt. - 16' 5"		DOUBLE	€ 36, <sup>90</sup>
<b>6 x 9</b>	13909/10EN		10 mt. - 32' 10"	E10 FUEL	DOUBLE	€ 35, <sup>00</sup>
<b>6 x 9</b>	13909/10EV		10 mt. - 32' 10"	E10 FUEL	DOUBLE	€ 35, <sup>00</sup>
<b>6 X 13</b>	01902/10		10 mt. - 32' 10"			€ 30, <sup>00</sup>
<b>6 X 13</b>	01902/10-V		10 mt. - 32' 10"			€ 30, <sup>00</sup>
<b>6 X 13</b>	01902-V		50 mt. - 164'			€ 127, <sup>00</sup>
<b>6,5 X 11</b>	11923/10-S		10 mt. - 32' 10"	UNLEADED FUEL	DOUBLE	€ 74, <sup>90</sup>
<b>7 x 10</b>	01922/A		100 mt. - 328'			€ 120, <sup>00</sup>
<b>7 x 10</b>	01922/A/10		10 mt. - 32' 10"			€ 15, <sup>00</sup>
<b>7 x 10</b>	01922/A10V		10 mt. - 32' 10"			€ 15, <sup>00</sup>
<b>7 x 10</b>	01922/A-V		100 mt. - 328'			€ 120, <sup>00</sup>
<b>8 x 13</b>	11932/10-V		10 mt. - 32' 10"			€ 27, <sup>00</sup>
<b>8 x 13</b>	13912/10EN		10 mt. - 32' 10"	E10 FUEL	DOUBLE	€ 84, <sup>90</sup>
<b>8 x 13</b>	13912/10EV		10 mt. - 32' 10"	E10 FUEL	DOUBLE	€ 84, <sup>90</sup>
<b>10 x 15</b>	11934/10-V		10 mt. - 32' 10"			€ 31, <sup>00</sup>



13908-A BLUE	€ 3,70 + IVA/VAT
13908-R RED	€ 3,70 + IVA/VAT



13908 BLACK	€ 3,70 + IVA/VAT
13908-AR ORANGE	€ 3,70 + IVA/VAT



OFF-ROAD GOGGLES



OFF-ROAD GRIPS



12933-A BLUE	€ 3,70 + IVA/VAT
12933-R RED	€ 3,70 + IVA/VAT



12933 BLACK	€ 3,70 + IVA/VAT
12933-AR ORANGE	€ 3,70 + IVA/VAT



12932-A BLUE	€ 3,70 + IVA/VAT
12932-R RED	€ 3,70 + IVA/VAT



12932 BLACK	€ 3,70 + IVA/VAT
12932-AR ORANGE	€ 3,70 + IVA/VAT



ROAD GRIPS



Photo M. Crivellari

13980-CB

↕ 2,80 m



DIS-10

↕ 50 cm Display stand grips not included







12969-BS € 19,00 + IVA/VAT



12969-RO € 19,00 + IVA/VAT



12969-NS € 19,00 + IVA/VAT



12971-TCN € 18,00 + IVA/VAT



12971-CCG € 27,00 + IVA/VAT



12971-SCB € 22,00 + IVA/VAT



12971-BLN € 21,00 + IVA/VAT



FRONT

**ART OF SPEED**

BACK

14906-MAS	size S	€ 25,00 + IVA/VAT
14906-MAM	size M	€ 25,00 + IVA/VAT
14906-MAL	size L	€ 25,00 + IVA/VAT
14906-MAXL	size XL	€ 25,00 + IVA/VAT
14906-MXXL	size XXL	€ 25,00 + IVA/VAT



**OFFICIAL-BLUE**

14902-OAS	size S	€ 20,00 + IVA/VAT
14902-OAM	size M	€ 20,00 + IVA/VAT
14902-OAL	size L	€ 20,00 + IVA/VAT
14902-OAXL	size XL	€ 20,000 + IVA/VAT



**OFFICIAL**

14902-OS	size S	€ 20,00 + IVA/VAT
14902-OM	size M	€ 20,00 + IVA/VAT
14902-OL	size L	€ 20,00 + IVA/VAT
14902-OXL	size XL	€ 20,00 + IVA/VAT

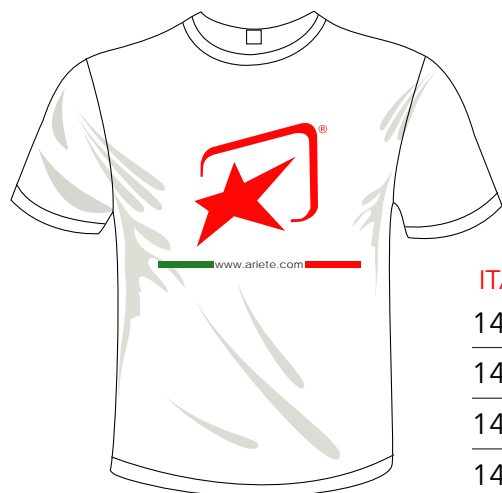

**ITALIA**

14903-IS	size S	€ 20,00 + IVA/VAT
14903-IM	size M	€ 20,00 + IVA/VAT
14903-IL	size L	€ 20,00 + IVA/VAT
14903-IXL	size XL	€ 20,00 + IVA/VAT



**HERITAGE Original Vintage T-shirt**

14905-HES	size S	€ 30,00 + IVA/VAT
14905-HEM	size M	€ 30,00 + IVA/VAT
14905-HEL	size L	€ 30,00 + IVA/VAT
14905-HEXL	size XL	€ 30,00 + IVA/VAT







**Harri's**<sup>®</sup>

**ariete**<sup>®</sup>

**ARI**<sup>®</sup>  
THE ORIGINAL  
FORK OIL SEALS



are the trademarks of

**SANDRO MENTASTI S.R.L.**

Via Giovanni Macchi, 30 - 21100 Varese - Italy

Tel. +39 0332 310100 - info@ariete.com



N45° 48' 36.211" - E8° 47' 45.392"

Nicola Dutto  
Photo F.Gasperi

Jack Miller  
Photo A. Farinelli

Giorgio De Angelis  
Photo VD Photo



f Ariete  
@ariete\_official



Copyright©  
Sandro Mentasti s.r.l.



[www.ariete.com](http://www.ariete.com) - [www.mentasti.com](http://www.mentasti.com) - [info@ariete.com](mailto:info@ariete.com)

SMQM CODE: CACC2020

All rights reserved. No part of this book may be reproduced or transmitted in any form or by any means, electronic or mechanical, including photocopying, recording or by any information storage or retrieval system without permission in writing from Sandro Mentasti s.r.l.